

**"4-20 UNIT"
LEVEL REGULATION & REMOTE
MONITORING ASSEMBLY FOR ESPACE, RCB & ARPEGE
USER AND MAINTENANCE GUIDE**

AIR LIQUIDE - DMC

Parc Gustave Eiffel - 8, avenue Gutenberg
Bussy-Saint-Georges - 77607 Marne La Vallée Cedex 3 - France
Tel.: +33 1 64.76.15.00 - Fax: +33 1 64.76.16.99
www.dmc.airliquide.com



Only personnel who have read this guide in full and the safety instructions in document NH78380 are authorised to manipulate and use the apparatuses described in this document.

Like all equipment, your device may suffer an electrical or electronic fault. The manufacturer cannot be held liable for stored products of any nature and which might be lost as a result of this fault, even during the warranty period.



Under directive WEEE 2002/96/EC, this device may contain electronic components which are hazardous to the environment. Owners are requested to contact the manufacturer or vendor of the apparatus to find out the procedure to be followed for the safe disposal of the apparatus. The manufacturer cannot be held responsible for the consequences of failure to follow the prescribed recycling procedure.

1 - PRESENTATION

This user guide is designed to describe the operation and explain the various settings of the 4-20 UNIT. The 4-20 UNIT is a peripheral option to the standard electronics supplied with cryogenic containers such as the level and temperature gauges in the form of two blue units.

The blue units which can be connected to the 4-20 UNIT are level gauge ACC-GNL-10 and temperature gauge ACC-GNL-11

The 4-20 UNIT is used to regulate the nitrogen level within a container fitted with level and temperature gauges for storing in the liquid or gas phase. This product is also used to monitor the level and temperature remotely using two 4-20mA loops.

The 4-20 UNIT consists of a pearlescent grey metal box containing a back panel board (mother board) to which are connected a level regulation board, a 4-20 mA level remote monitoring board and a 4-20 mA temperature remote monitoring board. The unit must be fitted with a regulation board and can have one or two remote monitoring boards as options.

The 4-20 unit is positioned on the edge of the corresponding cryogenic container. The 4-20 UNIT is held on the container using four retaining screws on a stainless steel plate if the dimensions of the container do not allow it to be located on the wall or else on the container itself. The unit can be fitted to all containers in the ESPACE and RCB ranges as well as the ARPEGE 40/70/110/140/170.

Each board is able to use the "DATA/CLOCK" signal from the level and temperature gauge units, generate alarms and manage commands and dry contacts. The regulation board is also able to control a solenoid valve and data transmission remote monitoring boards (measurements) in an analogue manner on a 4-20mA connection.

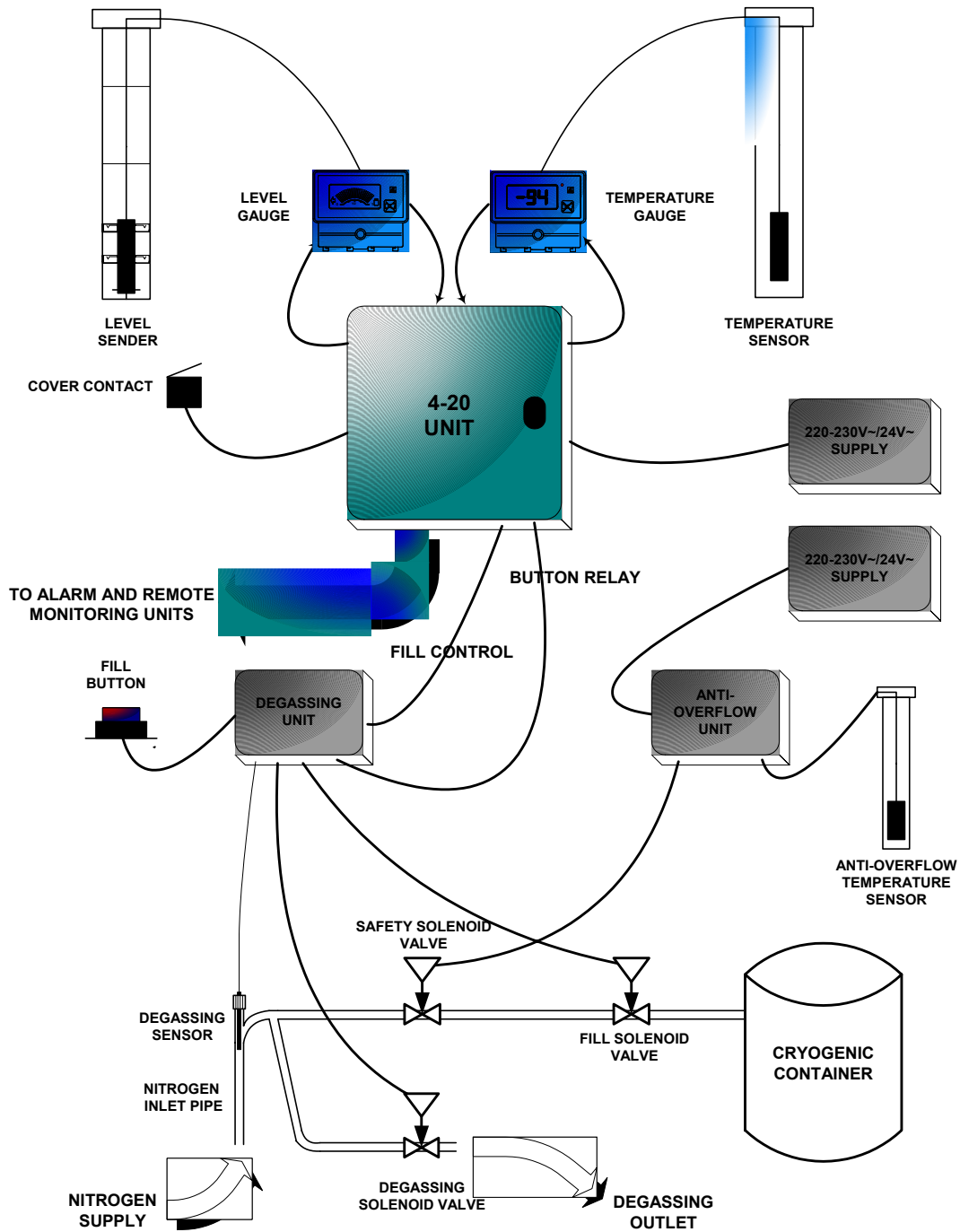

General layout of a cryogenic container fitted with a 4-20 UNIT

2 – DESCRIPTION & OPERATION

2.1 – General description of the 4-20 UNIT

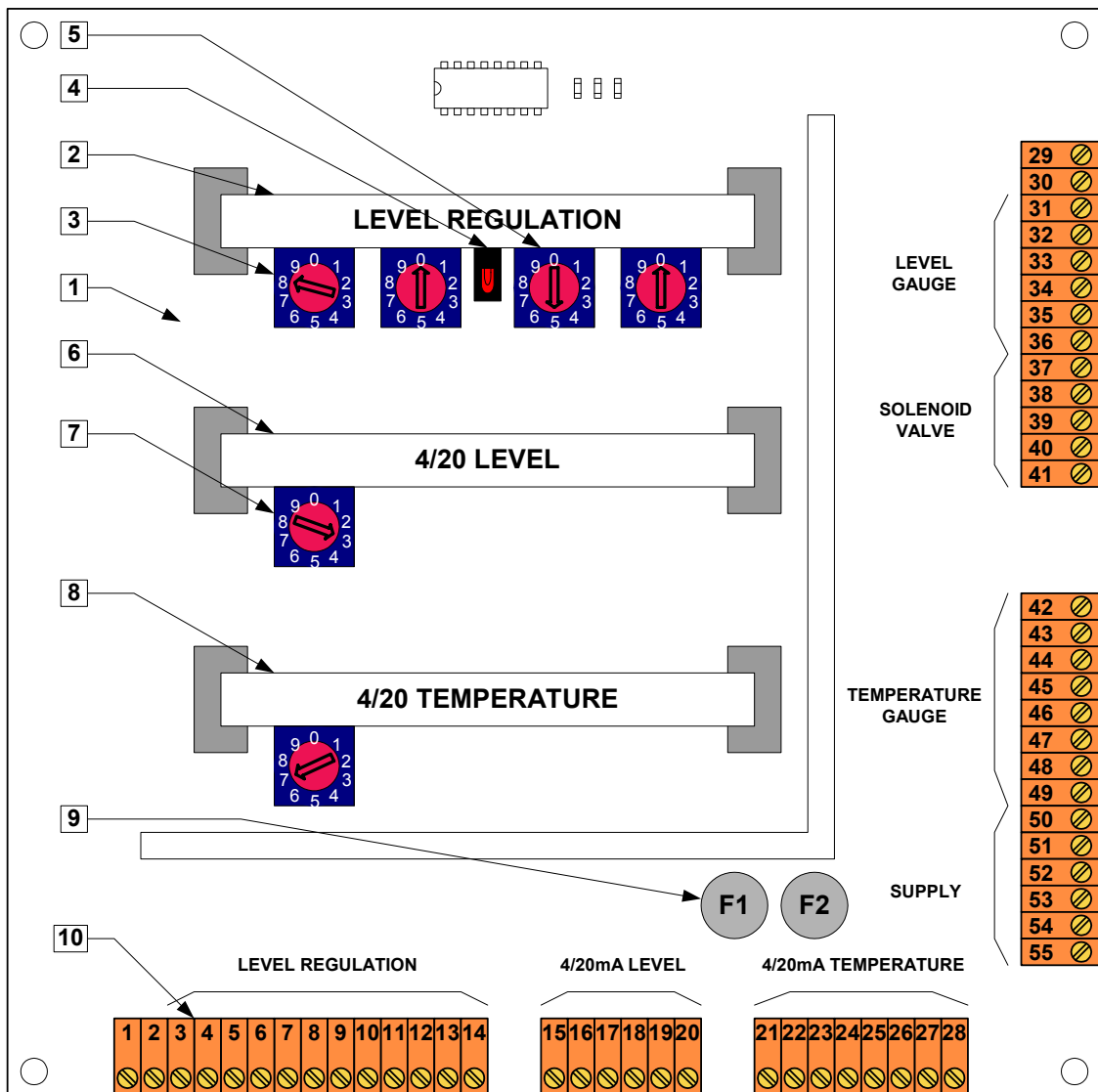

Fig. 5 - Presentation of the base unit













(Fitted with Regulation, Level Remote Monitoring and Temperature Remote Monitoring boards)

- | | |
|---|--|
| 1 – Base unit mother board | 6 – Level remote monitoring board (option) |
| 2 – Regulation board | 7 – Min level alarm encoding wheel |
| 3 – High threshold adjustment encoding wheels | 8 – Temperature remote monitoring board (option) |
| 4 – Low threshold adjustment encoding wheels | 9 – Fuses F1, F2: T2A |
| 5 – Threshold adjustment fault LED | 10 – Terminals (see details below) |

CONNECTIONS TO THE TERMINALS

- Level gauge:
 - 31-32 Gauge low level (input)
 - 33 -36 Level DataClock signal
- Solenoid valve:
 - 39-40 Coil excitation
 - 41 Earth
- Solenoid valve control:
 - 37-38 Manual fill control button
 - Fill command from temperature gauge
- Supply:
 - 54-55 24 VAC
 - 53 Earth
- Level regulation board:
 - 3-4 Gauge low level contact (output)
 - 5-6 Solenoid valve status information contact
 - 7-8 Simultaneous fill control (output)
 - 9-10 Low level alarm contact
 - 11-12 High level alarm contact
 - 13-14 Simultaneous fill control (input)
- Level Remote Monitoring Board:
 - 15-16 Level Min Threshold Alarm contact (encoder wheel)
 - 17-18 Connection fault contact
 - 19 Level 4/20 mA loop -
 - 20 Level 4/20 mA loop +
- Cover switch:
 - 29-30 Switch input
 - 1-2 Cover information relay
- Level and Temperature Gauge Supplies:
 - 51-52 24 VAC
 - 50 Earth
- Temperature gauge:
 - 44-45 Temperature gauge alarm contact (input)
 - 46 -49 Temperature DataClock signal
 - 42-43 Fill command
- Temperature Remote Monitoring Board:
 - 21-22 Thermometer alarm contact (output)
 - 23-24 Connection fault contact
 - 25-26 Temp Min Threshold Alarm contact (encoder wheel)
 - 27 4/20 mA loop -
 - 28 4/20 mA loop +

Cables (with degassing)

No.	Purpose	Appearance	Connects from	Connects to
T	Measurement output from temperature gauge		Temperature gauge	4-20 mA unit
N	Measurement output from level gauge		Level gauge	4-20 mA unit
1	Power supply to temperature gauge		Temperature gauge	4-20 mA unit
2	Power supply to level gauge		Level gauge	4-20 mA unit
3	Power supply to 4-20 mA unit		Power supply unit	4-20 mA unit
4*	Container lid open/closed status information		Container	4-20 mA unit
5*	Data from manual filling pushbutton		Container	4-20 mA unit
6	Filling solenoid valve control		Degassing unit	Fill solenoid valve
7**	Degassing solenoid valve control		Degassing unit	Degassing solenoid valve
8**	Solenoid valve control output		4-20 mA unit	Degassing unit
9	Pushbutton delay		4-20 mA unit	Degassing unit
10*	4-20 mA output (temperature data)		4-20 mA unit	User equipment
11*	4-20 mA output (level data)		4-20 mA unit	User equipment







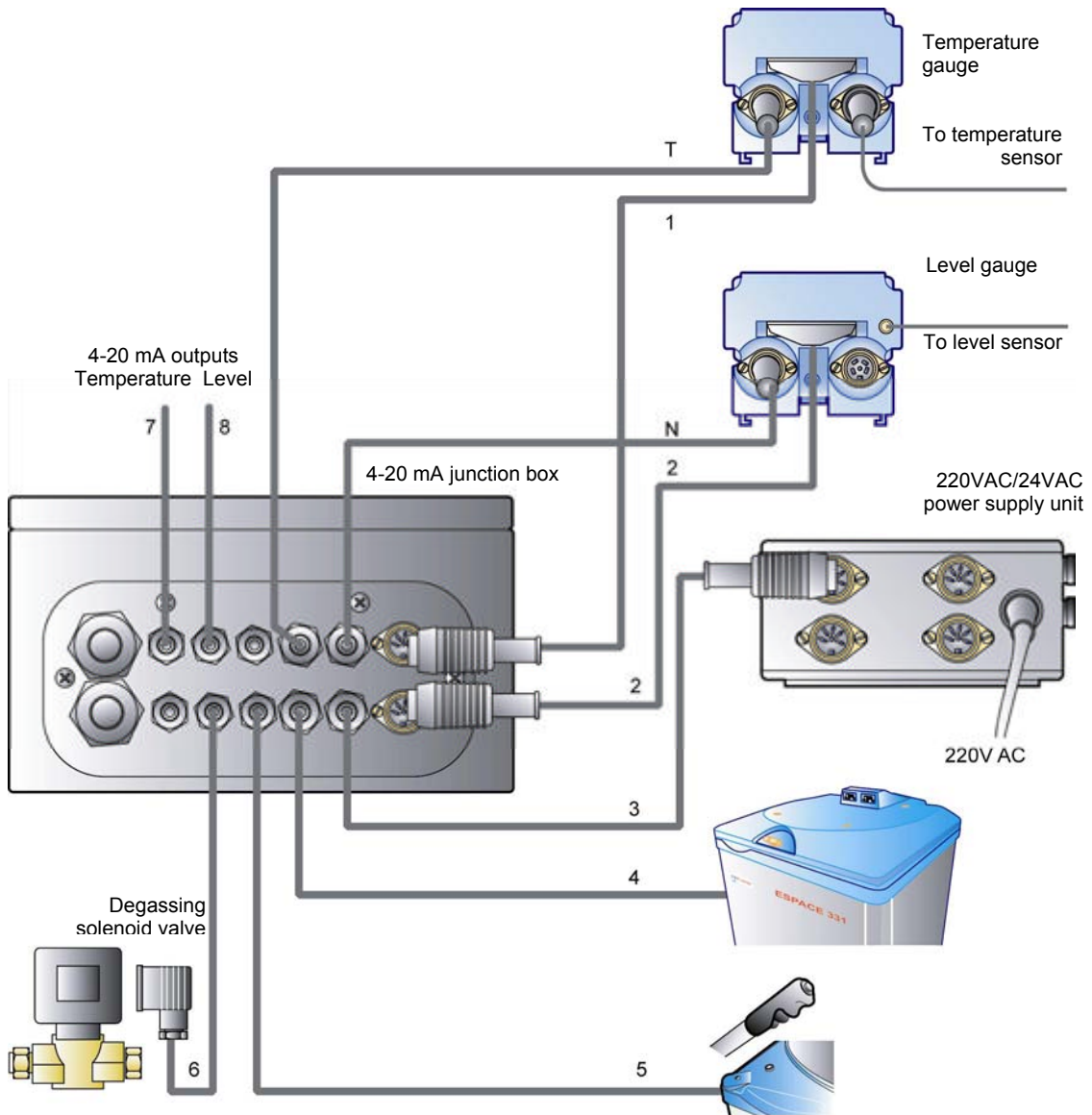



(*) Cable not supplied by Air Liquide.

(**) Supplied with the relief unit.

Overview of connections (without degassing)



Cables (without degassing)

No.	Purpose	Appearance	Connects from	Connects to
T	Measurement output from temperature gauge		Temperature gauge	4-20 mA unit
N	Measurement output from level gauge		Level gauge	4-20 mA unit
1	Power supply to temperature gauge		Temperature gauge	4-20 mA unit
2	Power supply to level gauge		Level gauge	4-20 mA unit
3	Power supply to 4-20 mA junction box		Power supply unit	4-20 mA unit
4*	Container lid open/closed status information		Container	4-20 mA unit
5*	Data from manual filling pushbutton		Container	4-20 mA unit
6	Degassing solenoid valve control		4-20 mA unit	Degassing solenoid valve
7*	4-20 mA output (temperature data)		4-20 mA unit	User equipment
8*	4-20 mA output (level data)		4-20 mA unit	User equipment

(*) Cable not supplied by Air Liquide.

2.2 – Detailed description of the 4-20 UNIT

The container is fitted with a supply and connection base unit. This is connected to the temperature and level gauges using an 8-pin DIN connector.

The fill pipework is fitted with a solenoid valve.

The base unit is fitted with two 24 VAC DIN plugs used to supply the two gauges.

2.2.1 – Level regulation

In this case, the base unit is fitted with an electronic regulation board.

The card is fitted with 4 encoding wheels used to adjust the max and min thresholds between which the liquid level should be regulated.

The high level threshold is adjusted on the 2 left hand encoder wheels (tens, unit). Likewise, the low level threshold is adjusted on the 2 right hand encoder wheels.

An LED informs the user if the encoder wheels are incorrectly configured, especially if the thresholds are inverted during adjustment or if the authorised ranges for the 2 thresholds are exceeded.

The level can be regulated using 4 distinct regulation modes which are:

- Automatic fill mode,
- Simultaneous fill mode,
- Manual fill mode,
- Semi-automatic fill mode.

The container is in Automatic mode by default. The mode which has priority over all the others is Manual fill mode, so that nitrogen filling of the container can be stopped by releasing the button when the level is above the Low Level Threshold.

Automatic mode

When the low fill level threshold is reached, the solenoid valve opens.

When the high fill level threshold is reached, the solenoid valve closes.

In parallel to the solenoid valve, a dry contact is available on the terminal to monitor the control status of the solenoid valve remotely (on or off, activated or not, open or closed).

For safety reasons, the minimum low level threshold is 10%.

Likewise, the maximum low level threshold is 90%.

When filling occurs normally, the solenoid valve automatically closes when the high fill level threshold is reached. If the solenoid valve fails to close, an alarm contact (high level alarm contact) opens when the level has risen by 5 or 10% above the high fill level threshold in the liquid phase or 15% in the gas phase. The high level alarm contact only closes when the level falls back below the high fill threshold (i.e. 5, 10 or 15% below the alarm trigger point).

If for any reason, filling does not occur (refill container empty or solenoid valve faulty), another alarm contact (low alarm contact) opens when the level falls to 5 or 10% below the low fill level threshold in the liquid phase or 15% below the same threshold in the gas phase.

In the liquid phase only, if the level falls to 10% below the low level threshold, automatic filling is prohibited for safety reasons (e.g. if the level sensor is faulty or disconnected). In this condition, only manual filling remains operational.

For this reason, in the liquid phase, initial filling can only be performed manually until the sensor measures a value greater than that given above (i.e. 10% below the min threshold).

When the value read on the level gauge is 10% below the low level threshold programmed on the level board (refill container empty or sensor faulty), both "high" and "low" alarms are triggered simultaneously.

In the gas phase only, if the level falls to a value of 10%, automatic filling is prohibited for safety reasons (e.g. if the level sensor is faulty or disconnected). In this condition, only manual filling remains operational.

For this reason, in the gas phase, initial filling can only be performed manually until the sensor measures a value greater than 10%.

When the value read on the level gauge is below 10% (refill container empty or sensor faulty), both "high" and "low" alarms are triggered simultaneously.

The diagram below shows all of the regulation cycles in automatic mode as a function of time. To understand the curve correctly, bear in mind that actions performed at time t_k and shown in the boxes take into account the actions performed previously at times t_{k-1} , t_{k-2} , ... and t_0 .

For example, if the solenoid valve is already open and if it needs to be open, the action is not shown again.

LEVEL REGULATION CURVE

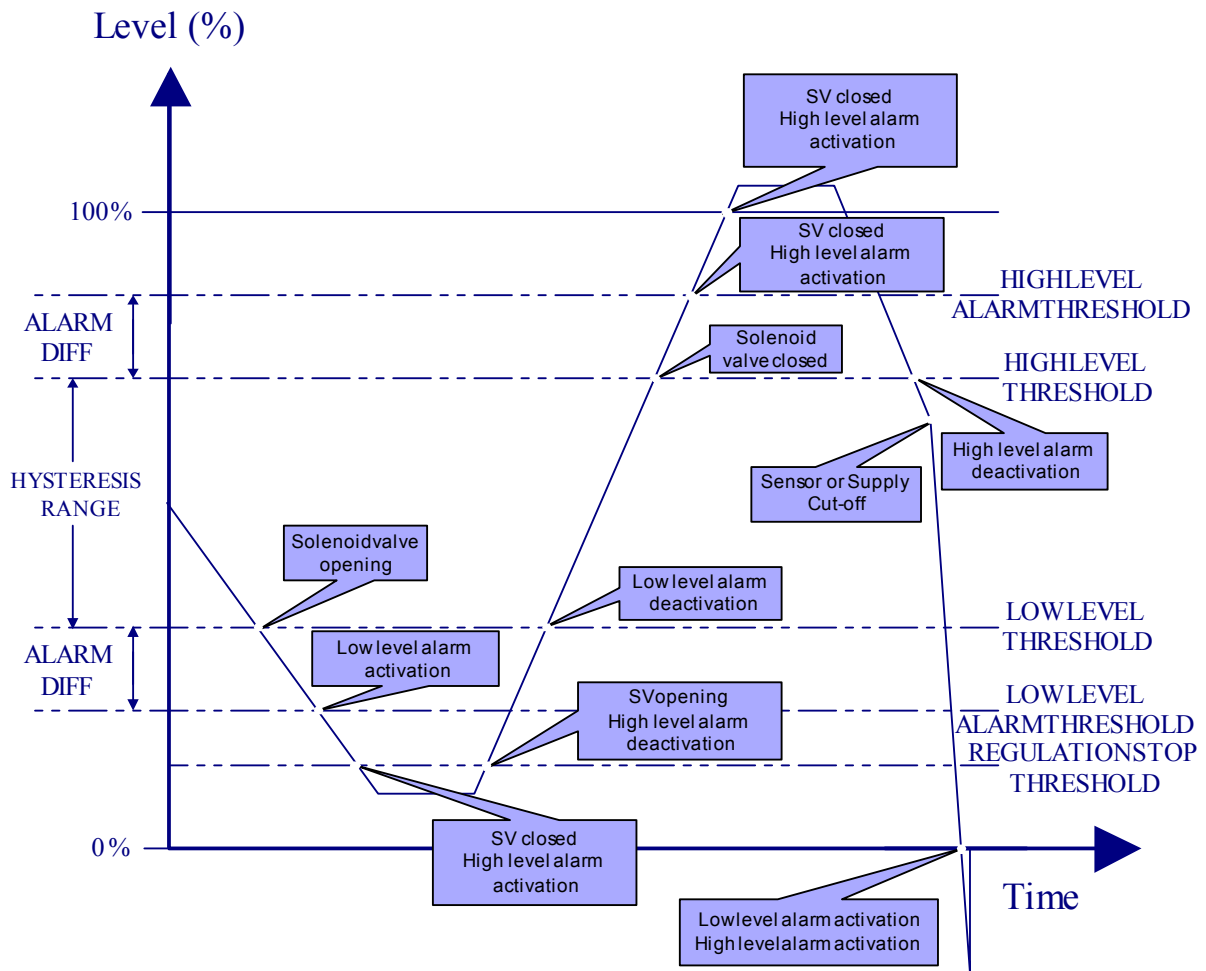

	REGULATIONSTOP THRESHOLD
LIQUID PHASE	Low Threshold-10%
GAS PHASE	10%

Simultaneous mode

When connecting containers together, simultaneous mode enables one of the containers in the network to generate a positive pulse of approximately 2 seconds at the terminals of the **Automatic Fill** contacts by momentarily closing the corresponding relay. This pulse is generated when the container reaches its Low Regulation Threshold (only when the level drops).

The other interconnected containers receive the simultaneous fill information via the **External Control** contacts, causing a relay to close which generates the pulse signalling the simultaneous fill request.

Filling controlled in this way by a connected container will only occur if the nitrogen level in the controlled container is between the Regulation Stop Threshold and the High Level Threshold. Simultaneous filling ends when each of the connected containers reaches its High Level Threshold. All containers then switch back to automatic regulation mode.

To connect the containers correctly (ESPACE used as an example here), the wiring diagram is shown below:

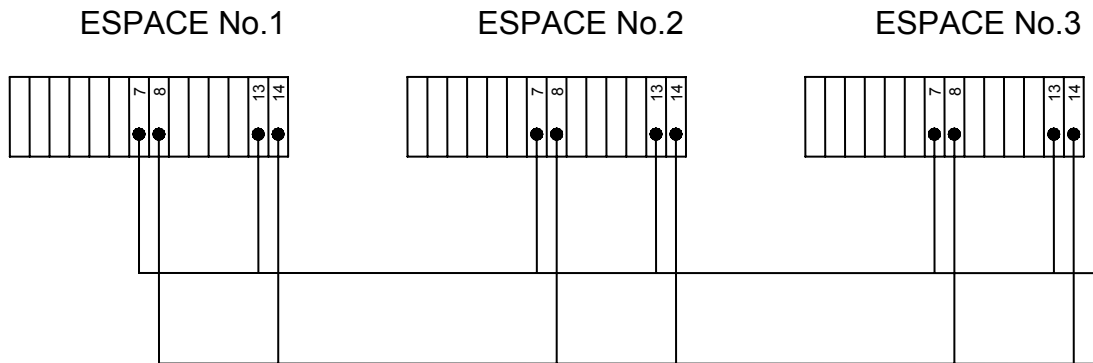

Filling can be triggered before the low level threshold is reached by a command from outside the container.

The end of filling is always controlled by the high level threshold. If the container is faulty (level 10% below the low level threshold in the liquid phase and level below 10% in the gas phase), filling is prohibited.

The **Regulation Stop Threshold** is used to describe the threshold at which the container switches to faulty.

This may be useful when several containers are connected to a vacuum line. All containers can be filled at the same time when the line is cooled. Reciprocally, the regulation board supplies a control pulse to start filling neighbouring containers. In this case, the connection shown on the previous diagram should be used.

A maximum of fifteen containers can thus be connected together in simultaneous mode.

This function can also be used to perform programmed fill operations periodically, using an external device connected to the container network.

Manual Mode & Semi-Automatic Mode

The level regulation board also has an input used for both Manual Filling and Semi-Automatic Filling via a button and Filling controlled by the temperature gauge (regulation by temperature). The user can therefore perform a manual fill by pressing the button on the cover or on the end of the container handle. This button causes the solenoid valve to open for as long as the button is pressed, without modifying the initially programmed calibration.

When the container is empty (level below 0%), the only way of filling it is to press the button. Pressing and holding the button causes the container to switch back to Manual Fill mode.

When the level is above 0%, and when the button is pressed 4 times in a row separated by a maximum duration of 1.5 seconds, the container switches to semi-automatic mode. The button does not have to be maintained pressed. Filling is prohibited when the level reaches the regulation High Level Threshold.

Manual filling can therefore be activated without a low threshold value, up to the High Level Threshold.

However, semi-automatic filling can only be activated above 0% and up to the High Level Threshold.

Important note: When the 4-20 UNIT is fitted with a degassing kit, pressing and holding the manual fill button causes the container to fill **without** degassing the nitrogen supply line. However, for a semi-automatic fill control (4 consecutive presses on the button), the container is filled **with** prior degassing of the nitrogen inlet line.

Dry contact alarm management (High & Low level alarms)

The Level Regulation board has 2 pairs of dry contacts which act as alarms.

The **Low Level Alarm** (contact closed during normal operation) and the **High Level Alarm** (contact closed during normal operation) are triggered respectively at 5 or 10% below and above the Low and High thresholds preset, for a regulation board in the liquid phase, to 5 or 10%.

For a regulation board in the gaseous phase, the alarms are triggered at 15% from the Low and High thresholds which cannot be configured and are set respectively to 40 and 80%.

The alarms are deactivated when the level is once again in the regulation range, i.e. between the preset Low and High thresholds.

The Low Level and High Level alarms are timed to trigger after 30 seconds. If the level returns to the regulation range after having exceeded one of the alarm thresholds even though the timer has not ended, the alarm remains inactive and the timer is reset to 30 seconds.

As soon as the level returns to the regulation range, the active alarm or alarms are cut off if it/they was/were active previously, without the deactivation timer.

Regulation control by the temperature gauge

The temperature gauge sends a fill control to the container when the temperature rises above its alarm threshold – Delta_T°C_ON, and for as long as it does not fall below its alarm threshold – Delta_T°C_OFF (by default, the temperature alarm threshold is set to -130°C on the temperature gauges). Delta_T°C_ON and Delta_T°C_OFF are +6°C and +16°C for temperature gauges ACC-GNL-11.

This control is interpreted by the regulation board as if it were a manual fill request.

2.2.2 – Level and Temperature Remote Monitoring

In this case, the base unit is fitted with one or two electronic remote monitoring boards for managing a 4-20 mA loop for the level or temperature or else both, depending on the number and location of the remote monitoring boards in the 4-20 unit.

The remote monitoring boards are designed to transmit the signal from the level and temperature gauges in the form of a 4 - 20 mA current to form a 4-20 current loop.

The output signal from the 4-20 mA remote control boards is therefore characterised by the intensity of its current which is proportional to the level or temperature value, depending on the operating configuration. Therefore at the output, the signal can have current values from 4 mA (characterising the minimum measurement to be transmitted) to 20 mA (corresponding to the maximum measurement to be transmitted).

For example:

- a 4 mA current corresponds to a temperature of 0°C and a level of 0%,
- an 8 mA current corresponds to a temperature of -50°C and a level of 25%,
- a 12 mA current corresponds to a temperature of -100°C and a level of 50%,
- a 16 mA current corresponds to a temperature of -150°C and a level of 75%,
- a 20 mA current corresponds to a temperature of -200°C and a level of 100%.

Connection and protection of the 4-20 mA loops

The 4-20 mA loop on each of the boards is not supplied by the remote monitoring boards. The receiver therefore has to be supplied independently with a direct voltage of between 7.5 and 36 volts (the use of a 24V DC steady voltage source is strongly recommended). The two remote monitoring boards are each protected against power supply inversions of the loop.

For safety reasons, the current loop providing the 4-20mA connection is opto-isolated between the loop transmitter and receiver so as to provide electrical protection of around 4kV.

Remote monitoring board dry contact alarm management

To adjust the encoder wheel on each of the remote monitoring boards, a minimum threshold alarm contact can be generated independently to the other alarms. The adjustment is possible between 0 and 90%, in 10% increments.

A second alarm contact is triggered if a connection fault occurs between the remote monitoring board and the level gauge.

The two alarm contacts are closed under normal level and/or temperature conditions (positive safety).

The temperature remote monitoring board has a **Min Threshold** alarm (contact closed for normal operation) which is triggered, independently to the alarms linked to regulation, as soon as the temperature rises above the threshold preset physically on the board as a percentage of the full scale and conversely cuts off when the temperature falls back below the threshold value.

Like practically all the alarms handled by the 4-20 Unit, the Min Threshold alarm is timed to trigger after 30 seconds (some are triggered after only 15 seconds). If the temperature falls back below the alarm threshold even though the timer has not ended, the alarm remains inactive and the timer is reset to 30 seconds.

As soon as the temperature falls back below the alarm threshold, this is cut off if it were previously active, without the deactivation timer.

For example, if the Min Threshold alarm is preset to 70%, the timer starts as soon as the measured temperature is above $-200^{\circ}\text{C} * 70\% = -140^{\circ}\text{C}$.

The second alarm (contact closed for normal operation) indicates a **Connection Fault** between the gauge transmitting the measurement and the 4-20 Unit. The alarm is triggered when the time interval exceeds 15 seconds between two measurement updates received by the 4-20 temperature board and is deactivated as soon as a new measurement is received from the gauge.

The 4-20 mA connection is always and simultaneously cut off when this alarm is activated, causing the loop current to be reset.

The level remote monitoring board has a **Min Threshold** alarm (contact closed for normal operation) which is triggered, independently to the alarms linked to regulation, as soon as the level falls below the threshold preset physically on the board as a percentage of the full scale and conversely cuts off when the level rises back above the threshold value.

Like practically all the alarms handled by the 4-20 Unit, the Min Threshold alarm is timed to trigger after 30 seconds (some are triggered after only 15 seconds). If the level rises back above the alarm threshold even though the timer has not ended, the alarm remains inactive and the timer is reset to 30 seconds.

As soon as the level rises back above the alarm threshold, this is cut off if it were previously active, without the deactivation timer.

For example, if the Min Threshold alarm is preset to 30%, the timer starts as soon as the measured level is below $100\% * 30\% = 30\%$.

The second alarm (contact closed for normal operation) indicates a **Connection Fault** between the gauge transmitting the measurement and the 4-20 Unit. The alarm is triggered when the time interval exceeds 15 seconds between two measurement updates received by the 4-20 level board and is deactivated as soon as a new measurement is received from the gauge.

The 4-20 mA connection is always and simultaneously cut off when this alarm is activated, causing the loop current to be reset.

3 – BOARD ADJUSTMENTS

3.1 – Configuring the adjustment thresholds (Regulation Board)

Configuring the regulation thresholds allows the regulation range to be set. Each of the thresholds can be adjusted to the nearest percent. The dynamics of this range are at least 8% and must be above 10% and below 99%.

The configuration of the board high and low regulation thresholds can be altered during operation and is therefore taken into account in real time.

To adjust the encoder wheels, a 3 mm flat screwdriver should preferably be used so as not to cause any damage.

If the range dynamics are not satisfied or if the parameters are inverted (high and low thresholds), an LED illuminates to warn the user adjusting the board that it has been incorrectly configured. The LED goes out after the current adjustment fault has been removed.

Configuring the board in the gas phase will permanently switch off the LED.

Any threshold adjustment errors will cause the safety thresholds to be used automatically. Therefore, if the thresholds are inverted or if the configuration is out of range, the default thresholds used are 50% for the Low Level Threshold and 80% for the High Level Threshold.

The threshold adjustment is only taken into account for a regulation board configured in the liquid phase to 5 or 10%.

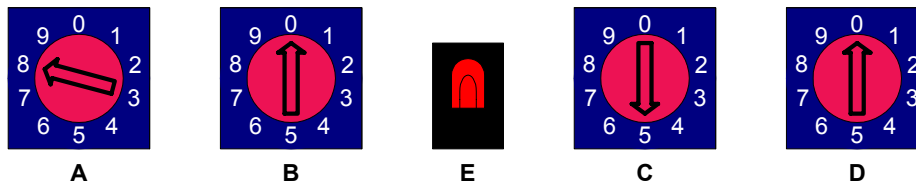

*Configurable part of the Regulation Card
(Front view, board inserted)*

COMPONENT	FUNCTION
A	TENS - HIGH LEVEL THRESHOLD
B	UNITS - HIGH LEVEL THRESHOLD
C	TENS - LOW LEVEL THRESHOLD
D	UNITS - LOW LEVEL THRESHOLD
E	ADJUSTMENT ERROR

3.2 – Remote Monitoring Board adjustment

To adapt to all types of loop reception and supply equipment, the loop dynamics, i.e. the full scale and the offset (4 mA) are independently adjustable.

The 4mA and 20mA must be adjusted on the one hand the first time the loop is installed on site and on the other hand, periodically every 12 - 18 months for maintenance purposes to ensure the accuracy of the values transmitted.

As an example of the orders of size, the dynamics can be adjusted between 14 and 18 mA and the loop offset from 3 to 5 mA.

4-20 mA loop adjustment procedure

For a complete unit, i.e. one with two remote monitoring boards, start the adjustment procedure with the level remote monitoring board.

1. Remove the remote monitoring board from the unit then configure the sliders so that the OFF slider (for offset) is in the ON position and the FSC slider (for full scale) is in position 2.
2. Replace the board in the unit.
3. Adjust the loop 4mA by turning the OFF potentiometer, preferably using a 1 mm wide flat screwdriver.
4. Remove the remote monitoring board from the unit then configure the sliders so that the OFF slider (for offset) is in position 1 and the FSC slider (for full scale) is in the ON position.
5. Replace the board in the unit.
6. Adjust the loop 20mA by turning the FSC potentiometer, preferably using a 1 mm wide flat screwdriver.
7. Remove the remote monitoring board from the unit then configure the sliders so that the OFF slider (for offset) is in position 1 and the FSC slider (for full scale) is in position 2.
8. Replace the board in the unit. The board is now adjusted.

*Note: The operator has **just over thirty minutes** to adjust each parameter. When this time has elapsed, for safety reasons, the 4-20 loop automatically reverts to normal mode. To switch the system back to adjustment mode, simply disconnect then reconnect the corresponding remote monitoring board.*

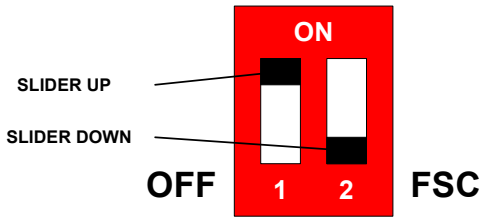

SLIDER CONFIGURATION FOR 4 mA ADJUSTMENT

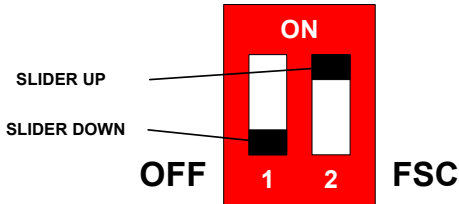

SLIDER CONFIGURATION FOR 20 mA ADJUSTMENT

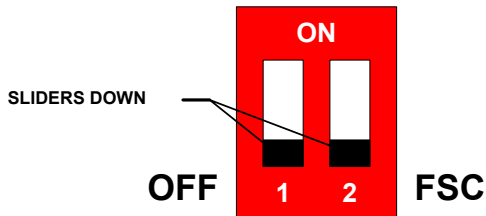

SLIDER CONFIGURATION FOR NORMAL MODE

*Loop adjustment part of the remote monitoring board
(View of the board, component side)*

Configuring the min threshold alarm

The min threshold alarm can be configured during operation and is therefore taken into account in real time. The adjustment is possible between 0 and 90%, in 10% increments.

To adjust the encoder wheel, a 3 mm flat screwdriver should preferably be used so as not to cause any damage.

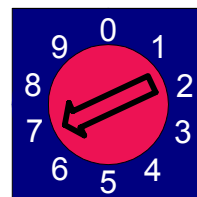
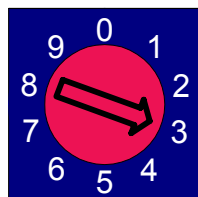

*Default adjustment of the board encoder wheels
Remote monitoring: level (left) and temperature (right)*

4 – REPLACEMENT PARTS AND ACCESSORIES

Some components subject to high stresses or those which are accidentally damaged during container operation may deteriorate and need to be replaced.

The following list gives the manufacturer's references of the proposed parts, allowing part orders to be completed correctly.

✓ *AUXILIARY EQUIPMENT OF THE 4-20 UNIT*

- | | |
|-----------------------------------|------------|
| - Level gauge | ACC-GNL-10 |
| - Temperature gauge | ACC-GNL-11 |
| - Quadruple 230 / 24 V power unit | ACC-GNL-19 |

✓ *4-20 UNIT:*

- | | |
|--|------------|
| - Regulation & Remote Monitoring assembly, liquid phase, alarms at 5% | NH 102899 |
| - Regulation & Remote Monitoring assembly, liquid phase, alarms at 10% | NH 102900 |
| - Regulation & Remote Monitoring assembly, gas phase, alarms at 15% | NH 102901 |
| - Metal unit with back panel board | ACC-GNL-3 |
| - Regulation board, liquid phase, alarms at 5% | ACC-GNL-15 |
| - Regulation board, liquid phase, alarms at 10% | ACC-GNL-16 |
| - Regulation board, gas phase, alarms at 15% | ACC-GNL-17 |
| - Level or temperature remote monitoring board | ACC-GNL-14 |

To find out the part numbers for other components used on your container, please contact your Air Liquide DMC agency.