

Indicator (level or temperature)

NH78363

User's manual





Copyright © 2006 by L'Air Liquide - DMC

First edition, English version 01/06/06.

All rights reserved. This document may not be reproduced in any way, in whole or in part, without the written permission of L'AIR LIQUIDE - DMC.

The information given in this manual is accurate to the best of our knowledge.

Air Liquide – DMC.

Parc Gustave Eiffel

8 Avenue Gutenberg

Bussy Saint Georges

77607 Marne la Vallée Cedex 3 - France

Tel.: +33 (0)1.64.76.15.00

Fax: +33 (0)1.64.76.16.99

E-mail: dmc.contact@airliquide.com or sav.dmc@airliquide.com

Web page: <http://www.dmc.airliquide.com>

Contents

1. About this manual.....	1
1.1 Objective of the manual	1
1.2 Who this manual is for	1
1.3 Structure of the manual	1
1.4 How to use this manual	1
1.5 Quick consultation of the manual.....	2
1.6 The accompanying CD	2
1.7 Trade names quoted in the manual	2
2. Safety	3
2.1 Symbols.....	3
2.2 Operator safety.....	4
2.3 Precautions in the event of failure.....	5
2.4 Destruction of the unit.....	6
3. Articles supplied	7

Indicator

4. General.....	11
4.1 Guide to components.....	11
4.2 Function.....	12
5. Description	15
5.1 Front panel	15
5.2 Rear view - Level indicator	18
5.3 Bottom panel	26
5.4 Top panel.....	27
5.5 Default parameters	27

5.6 Frame of ModBus signal/RS485.....	28
6. The display.....	31
6.1 Level indicator	31
6.2 Temperature indicator	34
6.3 Symbols used.....	36
6.4 Texts displayed	37
7. Operating graphics:	39
7.1 Thresholds on the storage tank	39
7.2 Graphics during operation	40

Menus

8. General notes	47
8.1 Comparison of the menus	47
9. The “Key” menu	51
9.1 Menu diagram	51
9.2 Accessing the menu	52
9.3 Entering the code	52
9.4 Leaving the “key” menu	53
10. The “Paramet. Display” menu	55
10.1 Menu diagram	55
10.2 Accessing the menu	55
10.3 Using the menu	56
10.4 Leaving the “Paramet. display” menu	57
11. The “Paramet. Storage” menu	59
11.1 Menu diagram	59
11.2 Accessing the menu	60
11.3 Using the menu	60
11.4 Leaving the menu	61

12. The “Factory Paramet. menu”	63
12.1 Menu diagram.....	63
12.2 Accessing the menu	63
12.3 Using the menu.....	64
12.4 Leaving the “Factory Paramet.” menu	65
12.5 Factory parameters.....	66
13. The “Calibration” menu	67
13.1 Menu diagram.....	67
13.2 Accessing the menu	67
13.3 Using the menu.....	68
13.4 Leaving the “Calibration” menu.....	69
14. The “Level Paramet” menu	71
14.1 Menu diagram.....	71
14.2 Accessing the menu	72
14.3 Using the menu.....	72
14.4 Leaving the “Level paramet.” menu	76
15. The “Temp. Parameters” menu	77
15.1 Menu diagram.....	77
15.2 Accessing the menu	77
15.3 Using the menu.....	78
15.4 Leaving the “Temp. Parameters” menu	80
15.5 Conversion table Centigrade/Fahrenheit	81

Installation

16. Structure of an installation	85
16.1 The various possible configurations.....	85
16.2 Configuration 1	86
16.3 Configuration 2	87
16.4 Configuration 3	88
16.5 Configuration 4	89

17. Mechanical installation	91
17.1 Replacing an old indicator	91
18. Electrical connections	95
18.1 Configurations (reminder).....	95
18.2 Configuration 1 (external unit)	96
18.3 Configuration 2 (without control).....	98
18.4 Configuration 3 (with level control)	100
18.5 Configuration 4 (with level control and Ethernet).....	102

Use

19. Before using the equipment	107
19.1 To determine the type of indicator	107
19.2 Mechanical installations.....	107
19.3 Electrical installation	108
19.4 Setting the parameters	109
20. Use	111
20.1 Summary of readings	111
20.2 Using the level indicator	113
20.3 Using the temperature indicator	114
20.4 Using the level and temperature indicator	114
20.5 Acknowledging the audible alarm	114
20.6 Manual filling	115
20.7 Semi-automatic filling	116
21. What to do if	117
22. Error messages	119

Appendices

23. Data sheet	123
23.1 Mechanical specifications	123
23.2 Electrical specifications.....	124
24. Accessories	127
25. European Union Declaration of Conformity	129
26. Guarantee and limit of liability	131
26.1 Guarantee.....	131
26.2 Limit of liability	132
27. Index	133

1. About this manual

1.1 OBJECTIVE OF THE MANUAL

This manual refers specifically to the level or temperature indicator. It describes its functionalities, the stages of mechanical installation and electrical connection, the parameter settings and how it is used.

1.2 WHO THIS MANUAL IS FOR

The manual is addressed to all professionals who wish to monitor the level and the temperature of their cryogenic storage tank.

1.3 STRUCTURE OF THE MANUAL

For ease of consultation, the structure of this manual follows the steps normally taken by the user, as described below:

Topic	Page
Description of the indicator (level or temperature)	9
Parameter settings	45
Mechanical and electrical installation	83
Use	105
Data sheet	123
CE conformity certification	15

1.4 HOW TO USE THIS MANUAL

The manual follows the same reading and configuration sequences as those followed by the users of the product (see section 1.3).

1.5 QUICK CONSULTATION OF THE MANUAL

Given the specific nature of the indicator and its application, we would advise against skimming through this manual. We strongly recommend reading the chapters thoroughly in the order given.

1.6 THE ACCOMPANYING CD

The accompanying CD contains:

- Manuals issued by L'air Liquide – DMC.
- This manual in electronic (*pdf*) format.

Note: you will need to have *Acrobat Reader* installed on your computer to be able to read or print from the manual in pdf format.

1.7 TRADE NAMES QUOTED IN THE MANUAL

Adobe and *Adobe Acrobat Reader* are trademarks of Adobe Systems Incorporated.

2. Safety

2.1 SYMBOLS



This symbol means:
Important information about using the equipment. Failure to follow the instructions given for this point does not result in danger for the user.



This symbol means:
You must refer to the instructions.



This symbol means:
Warning: In this manual, failure to observe or implement the instructions preceded by this symbol may cause bodily harm or damage to the apparatus and installations.



This symbol means:
Name and address of manufacturer.



This symbol means:
You **MUST** read the instructions for use.



This symbol means:
You **MUST** wear the appropriate hand protection gear.



This symbol means:
Warning: low temperature.

This apparatus is compliant to standard NF EN ISO 60601-1-2 applicable in the medical sector. It has been manufactured and tested to compliance with IEC standards on electromagnetic compatibility (EMC) and leaves the factory in a condition of perfect technical integrity. To keep the apparatus in perfect condition and ensure that it is used safely, you must follow the instructions and take note of the symbols given in this manual.

Before installing the apparatus, check that the voltage shown on the casing and the power supply voltage are the same.

When the device cannot be used in conditions of total safety, the apparatus should be withdrawn from service and protected against accidental usage.

Full safety cannot be guaranteed in the following cases:

- The apparatus is visibly damaged.
- The apparatus no longer works.
- After prolonged storage in unsuitable conditions.
- After severe damage sustained during transit.

2.2 OPERATOR SAFETY

2.2.1 General safety precautions

Only personnel who have fully read this manual and the safety recommendations (see NH78380) are authorized to handle and use the apparatus described in this document.

Like all similar devices, this apparatus is susceptible to electrical, electronic and mechanical failure. The manufacturer cannot be held liable for any products placed in storage subsequent to defective operation of the kind described above, even during the warranty period.

The apparatus described in this manual is designed exclusively for use by qualified personnel. Maintenance operations should only be carried out by qualified and authorized personnel. To ensure the safe and correct use of the apparatus during service and maintenance, it is essential that all personnel observe standard safety procedures.

2.2.2 Safe use of liquid nitrogen

The temperature of liquid nitrogen is $-196\text{ }^{\circ}\text{C}$. Therefore:



You must never touch objects which have been in contact with liquid nitrogen with your bare hands.



Always wear special gloves and visors when handling liquid nitrogen.



Liquid nitrogen used in storage tanks evaporates into the air; 1 litre of liquid nitrogen releases around 700 litres of nitrogen in the gaseous state. Nitrogen is an inert, non-toxic gas, but displaces oxygen when released into the atmosphere. Once the atmospheric oxygen content falls below 19% the human organism is at risk.

All rooms and areas that house tanks containing liquid nitrogen should be well ventilated at all times and equipped with at least one oxygen gauge. All personnel should be informed of the risks associated with the use of nitrogen.

2.2.3 The CE mark

The level or temperature indicator bears a  mark at the top (see Figure 5-14 on page 27). The  declaration is dealt with in section 25, on page 129.

2.3 PRECAUTIONS IN THE EVENT OF FAILURE

If you suspect that the integrity of the apparatus has been compromised (for example as a result of damage sustained during transit or during use), it should be withdrawn from service. Make sure that the withdrawn apparatus cannot be accidentally used by others. The defective apparatus should be handed over to authorized technicians for inspection.

2.4 DESTRUCTION OF THE UNIT



Under directive WEEE 2002/96/EC, this device may contain electronic components which are hazardous to the environment. Owners are requested to contact the manufacturer or vendor to find out the procedure to be followed for safe disposal. The manufacturer cannot be held liable for the consequences of failure to follow the prescribed recycling procedure.

3. Articles supplied

The product is delivered complete with:

Table 1: Articles supplied.

No.	Designation	Quantity
1.	This manual on CD-ROM.	1
2.	Level or temperature indicator (see table of codes below).	1
3.	Electrical power cable; length 2 m.	1

Code	Function
NH102885-N	Display, capture and transmission of the level to a 4/20 mA or RS485 remote transmission cabinet.
NH102885-T	Display, capture and transmission of the temperature to a 4/20 mA or RS485 remote transmission cabinet.
NH102886-N	Display, capture and transmission of the level in ModBus format (RS485 medium).
NH102886-T	Display, capture and transmission of the temperature in ModBus format (RS485 medium).
NH102886-NRG	Display, capture, control and transmission of the "gas" level in ModBus format (RS485 medium).
NH102886-NRL	Display, capture, control and transmission of the "liquid" level in ModBus format (RS485 medium).
NH102886-TNG	Display and capture of temperature and level, control and transmission of the "gas" level and temperature in ModBus format (RS485 medium).
NH102886-TNL	Display and capture of temperature and level, control and transmission of the "liquid" level and temperature in ModBus format (RS485 medium).

Figure 3-1:
Articles
supplied.

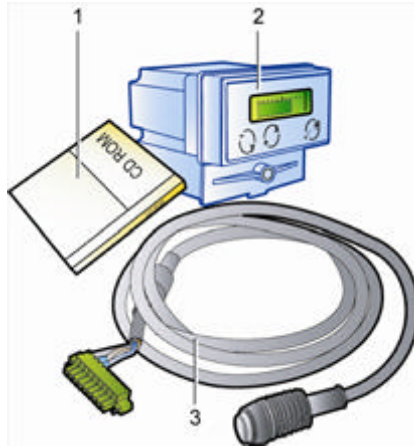

The indicator

4. General

4.1 GUIDE TO COMPONENTS

This illustration shows the parts of the front panel. These are described in greater detail in the following paragraphs and pages.

*Figure 4-1:
General view
of the
components
on the front
panel of the
indicator*

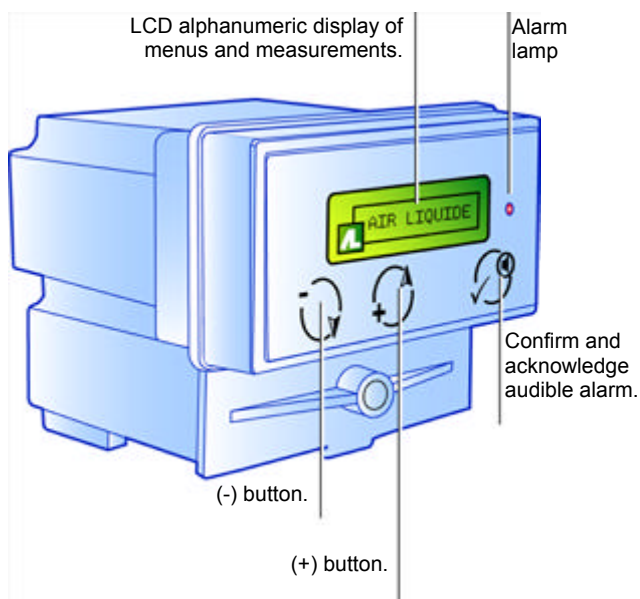

The illustration below shows the parts of the rear panel. These are described in greater detail in the paragraphs indicated.

Figure 4-2:
General view
of the
components
on the rear
panel of the
indicator

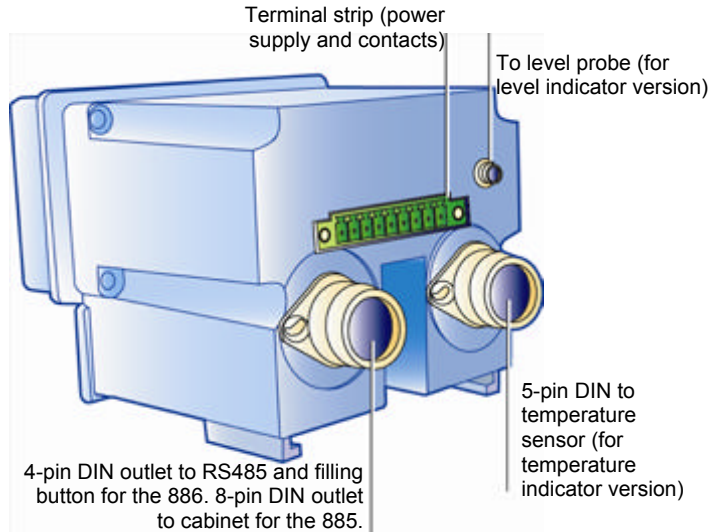

4.2 FUNCTION

The indicator is an electronic cabinet which, depending on the version, enables the temperature or the level in the container (liquid or gas) to be captured and displayed, with or without level control (CRT dry contact). The eight versions available are summarized in the following table.

Code	Level (capture/display)	Level control	Temperature (capture/display)	Data transmission
NH102885-N	■			To cabinet (1)
NH102885-T			■	To cabinet (1)
NH102886-N	■			RS485 (ModBus)
NH102886-T			■	RS485 (ModBus)
NH102886-NRG	■ (gas)	■		RS485 (ModBus)
NH102886-NRL	■ (liquid)	■		RS485 (ModBus)
NH102886-TNG	■ (gas)	■	■ (2)	RS485 (ModBus)
NH102886-TNL	■ (liquid)	■	■ (2)	RS485 (ModBus)

(1) 4-20 mA or RS485 output available on the cabinet.

(2) uses a type NH102887 (Cryoview) level indicator to display the level.

4. **General**

4.2.1 **Place of use**

The indicator is permanently mounted on the storage tank in a housing on the lid that is designed to accommodate it.

Two indicators are mounted side by side, one to display the temperature and the other the level of liquid. Depending on the type, the level indicator may or may not control the level of liquid in the circuit. The temperature indicator is never a control, it is only a display.

The level indicator is located on the right-hand side of the tank.

*Figure 4-3:
Two
indicators
mounted on a
tank.*

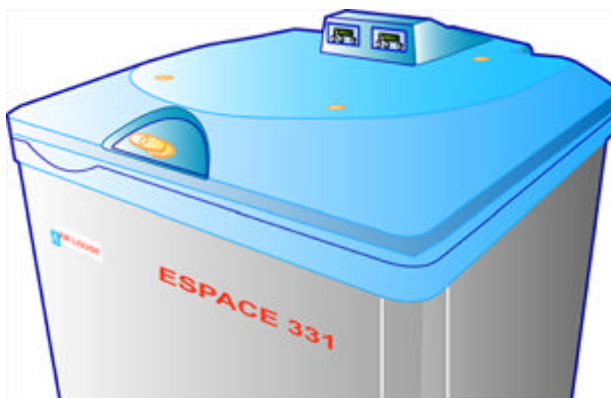

5. Description

5.1 FRONT PANEL

The front panel of the level or temperature indicator (NH102885 or NH102886) includes the following items.

Figure 5-1:
Front panel of
the indicator.

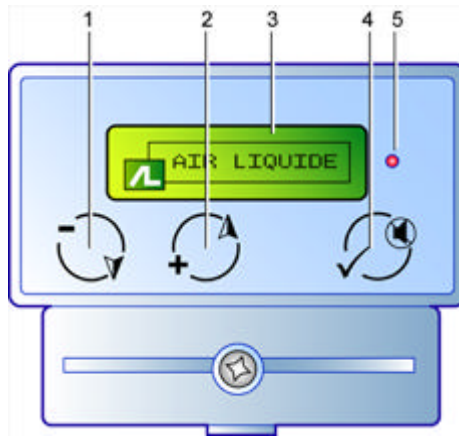













No.	Function
1.	Touch button (-).
2.	Touch button (+).
3.	Backlit alphanumeric LCD display

No.	Function
4.	Touch button (✓) to validate and acknowledge the buzzer
5.	Fault alarm indicator light (LED) (measurement or probe).

5.1.1 The buttons

There are three touch buttons and their functions are as follows:

-  (1) Decrement values or navigate downwards in menus. It can also be pressed at the same time as buttons (+▲) (2) or (✓) (4) (see table below).
-  (2) Increment values or navigate upwards in menus. It can also be pressed at the same time as buttons (+▼) (1) or (✓) (4) (see table below).
-  (4):
 - Confirm (OK) when using menus.
 - Acknowledge audible alarm. When an alarm is heard, pressing this button acknowledges (silences) the alarm; the alarm output remains active. It can also be pressed at the same time as buttons (+▼) (1) or (-▲) (2) (see table below).

Buttons pressed	Result
 	Manually actuates the filling solenoid valve (1). See § 6.1.4, page 32.
 	Displays the current parameter setting of the indicator. See § 6.1.5 on page 33 for the level indicator or § 6.2.5 on page 35 for the temperature indicator. Model TNG/L displays the level and temperature parameters together.
 	To call up the parameter setting menus, see § 9.2, page 52.
	Decrements values in parameter setting menus, or navigates downwards in other menus.
	Increments values in parameter setting menus, or navigates upwards in other menus.
	Confirm a selection or acknowledge buzzer. See § 6.1.4 on page 32 for the level indicator or § 6.2.4 on page 35 for the temperature indicator.

(1) on a level indicator only.

5.1.2 Alphanumeric display

Depending on the type of indicator (see section 4.2 on page 12), the backlit LCD (Figure 5-1: Front panel of the indicator. , no. 3) shows the level in the tank or its internal temperature. Section 6 on page 31 explains what the data means.

Figure 5-2:
Display
showing the
level (top) or
temperature
(bottom)

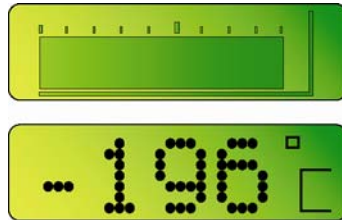

5.1.3 The alarm indicator

An indicator lamp (Figure 5-1: , no 5) lights up if one or more of the following causes persists for 30 seconds.

- Temperature and/or level limit overshoot (depending on the type of indicator)
 - **Level indicator not regulated:** if the level is at or below LLA . The alarm light goes out as soon as the level is above LLA .
 - **Level indicator regulated:** if the level is at or below LLA , or if the level is at or above HLA . The alarm light goes out as soon as the level is above LCL and/or below UCL .
 - **Temperature indicator:** when the temperature is at or above HTA . The alarm light goes out as soon as the temperature is above HTA .
- If the temperature or level sensor develops a fault (depending on the type of indicator – see section 4.2 on page 12).
- Error (parameter entered by the user is out of range or electronic fault).

This monitor light stays on all the time that the fault is present and cannot be acknowledged manually. The light goes out when the fault disappears. At the same time, the alarm switch is actuated (see § 5.2.3 on page 21).

5.1.4 The audible alarm

An audible alarm (buzzer) is activated after a 30-second delay. It is located inside the enclosure. The buzzer (stopping the buzzer) can be acknowledged at any time by pressing on the touch button (✓) (Figure 5-1: no. 4). However, the alarm lamp (Figure 5-1: no. 5) stays lit until the fault has disappeared. The conditions that activate the buzzer as the same as those that activate the alarm lamp (see section 5.1.2 on page 16).

5.2 REAR VIEW - LEVEL INDICATOR

The rear panel of the indicator contains:

Figure 5-3:
Rear panel of
the indicator.

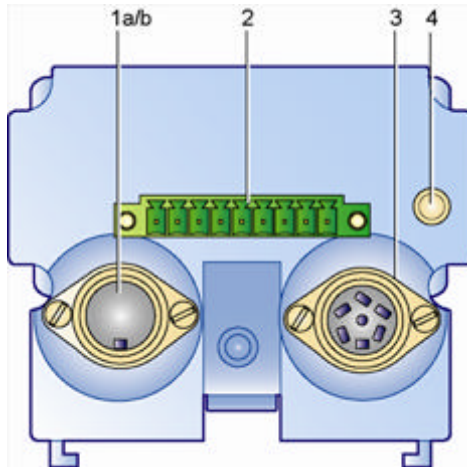

No.	Function
1a.	Connection to cabinet (A)
1b.	or RS485 connector and connection to manual filling button.

No.	Function
2.	Terminal strip.
3.	Temperature probe connector (A).
4.	Level probe connector (A).

(A): Only the appropriate connector for the type of indicator can be used.

5.2.1 RS485 connector – filling button

(any level indicator except NH102885-T and NH102885-N)

This 4-pin DIN lockable plug (1) is for transmitting data in ModBus format (RS 485 support) and/or connection to a manual pushbutton for manual control of the solenoid valve. It provides the following three types of connection:

- Connection to the RS485 plug of the second indicator in configurations 2, 3 or 4 (see paragraph 16.1 on page 85).

Figure 5-4:
Cable with
RS485
output but no
connection
to a filling
button.



No.	Function
1.	RS485 plug to indicator no. 1.
2.	RS485 plug to indicator no. 2.

No.	Function
3.	RS485 output or pushbutton input.

Figure 5-5:
Cables with
RS485 output
and connection
to a filling
button.

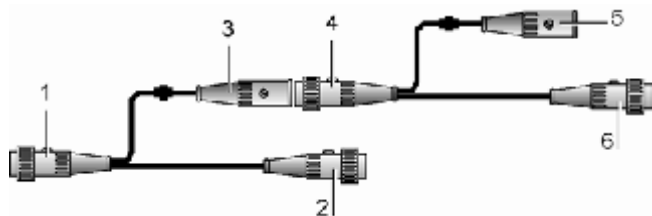

No.	Function
1.	RS485 plug to indicator no. 1.
2.	RS485 plug to indicator no. 2.
3.	Connection to second cable.

No	Function
4.	Second cable.
5.	To manual filling button.
6.	RS485 output.

- RS485 output for using the measurements. The data will then be sent to the user's recording equipment. Data will be transmitted to this output in ModBus format. Details of the format are given in section 5.6 on page 28.

- Connection to the manual control pushbutton located on the container of the storage tank filling solenoid valve. While this button is pressed, the filling solenoid valve is energized.



The measurements (temperature or level) are sent to the RS485 output. The indicator does not store any of the measurements.

*Figure 5-6:
The manual
filling button
on the storage
tanks.*

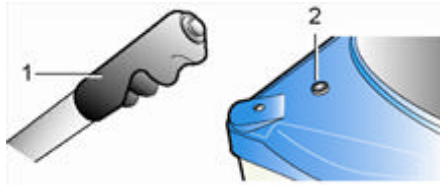

All the connectors have been pre-wired to prevent any connection errors.

5.2.2 Cabinet connector

Temperature and level indicators NH102885-T and NH102885-N

In this case this 8-pin DIN connector (Figure 5-3:, no 1 on page 18) is used for the remote transmission of data to the cabinet (the wiring is described in section 18.2 on page 96).

*Figure 5-7:
The outputs
connect the
indicators to
the cabinet.*

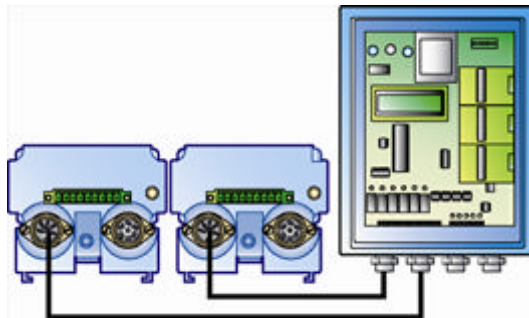



The analog remote transmission signal known as “Data/Clock” is a transmission signal for the level and temperature measurements that enables the temperature or level indicators to be processed so that temperature and/or level control can be added to them and so that the measurements can be transmitted in analog format (using one or two 4-20 mA loops) or digitally (using an RS485 connection and the ModBus protocol).

The Data/Clock signal is a digital signal corresponding to a synchronous serial transmission. This input signal consists of 3 elementary signals: a data signal (DATA), a clock signal (CLK) and a data validation signal (CS).

The signal is applied to communications between level and temperature indicators with either the 4-20mA enclosure or the RS485 cabinet, depending on which is used, via a cable with 8-pin DIN connectors.

5.2.3 Terminal strip

The 9-pin connector for the supply to the indicator and the transmission of the various signals (alarm, solenoid valve control) plugs into this terminal (Figure 5-3:

Rear panel of the indicator.

no. 2, on page 18). The table below gives details of the pin assignment for each type of indicator and the function of each of the terminals.



The terminal wiring is dealt with in section 18 on page 95.

In the event of a fault (equipment problem) each of the relays reverts to its non-energized state.

Figure 5-8: The terminal strip.
[A] Temperature indicator
NH102885-T.

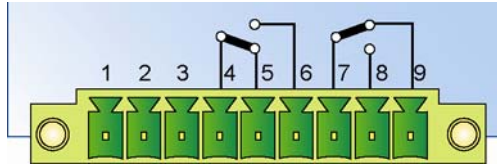

[B] Level indicator
NH102885-N.

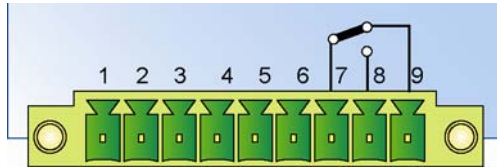

[C] Indicators for controlled liquid and gas levels
NH102886-NRL
NH102886-NRG
NH-102886-TNL
NH-102886-TNG.

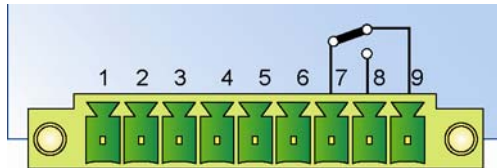

The area shown in blue is the interior of the indicator.

No.	Function	No.	Function
1.	Earth.	6.	See text.
2.	Phase 1 (24 V AC).	7.	Alarm relay output (common).
3.	Phase 2 (24 V AC).	8.	Alarm relay output (NO).
4.	See text.	9.	Alarm relay output (NC).
5.	See text.		

- **Terminal 1:** This connection enables the frame of the indicator (all types) to be connected to earth.
- **Terminals 2 and 3:** on all types of indicator these two terminals receive the 24 V AC supply from the 2 or 4 output power supply unit. See instruction manual ref. NH78339.

Figure 5-9:
Terminals 1, 2 and
3 for all indicators.

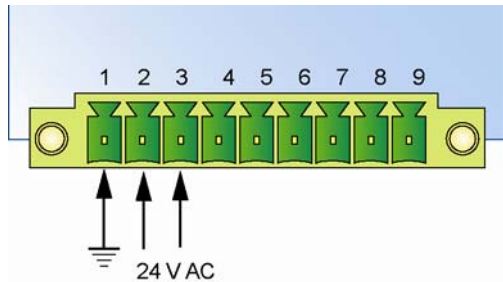

- **Terminals 4, 5 and 6:** these terminals are used on the following models:



Contacts [4-5] and [4-6] must NEVER be used at the same time as this could destroy the indicator.

- *Temperature indicator NH102885-T (see Figure 5-8, item [A] on page 22)*

Figure 5-10:
Terminals 4, 5 and
6 for an
NH102885-T
indicator.

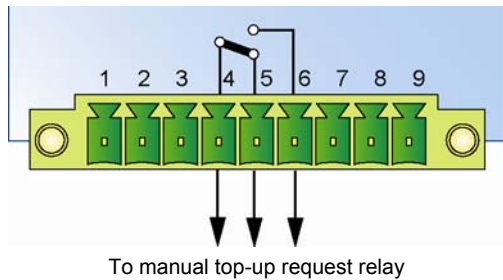

Corresponds to manual top-up request relay.

Terminals 4-5: the dry contact between terminals 4 and 5 is closed when there is no filling request, that is to say when the temperature is below ([HTA] – [16°C]) and conversely when it is above ([HTA] – [6°C]). These temperature limits become [HTA] – [11°F] and [HTA] – [29°F] respectively when the indicator is programmed in °F.

Terminals 4-6: the dry contact between terminals 4 and 6 is open when the temperature is below : ([HTA] – [16°C]).

- Level indicator NH102885-N (see Figure 5-8, item [B] on page 22)
Terminals 4, 5 and 6 are not used.
- Controlled level indicators NH102886-NRL, NH102886-NRG, NH-102886-TNL, NH-102886-TNG (see Figure 5-8, item [C] on page 22)

Figure 5-11:
Terminals 4, 5 and
6 for a controlled
level indicator.

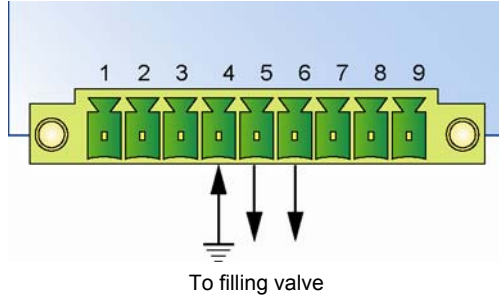

Corresponds to command from the filling solenoid valve.

Terminal 4: frame of the indicator (identical with terminal 1).

Terminals 5 and 6: connection to the filling solenoid valve.

The solenoid valve control relay is actuated when the level changes from a value above LCL to a level at or below LCL . It ceases to be active when the level is equal to or above UCL (these terms are explained in section 6.3 on page 36). This relay can also be activated by a local manual topping-up command from the tank (see Figure 5-6 on page 20).

- **Terminals 7, 8 and 9:** for all types of indicator, these terminals correspond to the alarm relay outputs (temperature or level).



Contacts [7-8] and [7-9] must NEVER be used at the same time as this could destroy the indicator.

The contact switches approximately 30 seconds after the alarm occurs.

Figure 5-12:
Terminals 7, 8 and
9 for the various
indicators.

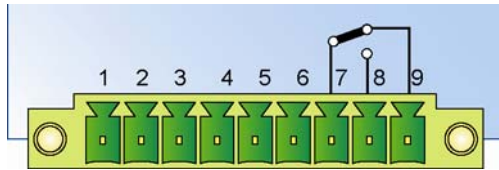

- Contacts 7 and 8 are closed when **alarm status** is **active** (temperature above HTA) if the alarm status has remained active for more than 30 seconds. Contacts 7 and 9 are open.
- Contacts 7 and 8 are open when **alarm status** is **not active** (temperature below HTA). Contacts 7 and 9 are closed.
- *Temperature indicator NH102885-T*
 - If a fault (probe, equipment or electronic) remains active during this time, the relay switches to the alarm position. The contacts return to their original state once the fault has disappeared.
 - If the temperature remains at or above HTA, the relay switches to alarm status. The contacts return to their original state once the temperature is strictly below HTA.
- *Level indicators NH102885-N, NH102886-NRL, NH102886-NRG, NH102886-TNL and NH102886-TNG*
 - If a fault (probe, equipment or electronic) remains active during this time, the relay switches to the alarm position. The contacts return to their original state once the fault has disappeared.
 - If the level stays at or below LLA, the relay switches to alarm status. The contacts return to their original state once the temperature is strictly above LCL.
 - If the level has stayed at or above HLA during this time, the contacts revert to their original state once the level is strictly below UCL.

5.2.4 Temperature sensor socket

This lockable 5-pin DIN socket (Figure 5-13: Reminder of the positions of the temperature and level sockets.

, no. 1) connects to the temperature sensor of the storage tank.



The temperature sensor socket can only be used together with the level sensor when the indicator is a type NH102886-TNL or NH102886-TNG.

*Figure 5-13:
Reminder of
the positions
of the
temperature
and level
sockets.*

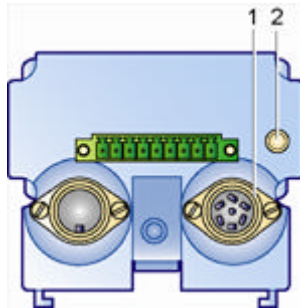

5.2.5 Level sensor socket

This is a type SMB socket (Figure 5-13: Reminder of the positions of the temperature and level sockets.

, no. 2) and is only used on a level indicator.



The level sensor cable simply clips into and out of the socket. There are no screw holes. However, it is important to check that the connector is properly positioned in the socket.

5.3 BOTTOM PANEL

The main features of this are the recesses that take the lug for securing the indicator to the storage tank.

5.4 TOP PANEL

This has the plate with the reference no. of the indicator, the date of manufacture, the type and the **CE** mark.



The references are explained in 4.2 on page 12.

Figure 5-14:
The main
feature of the
top of the
indicator is
the type
(marked with
an X).



5.5 DEFAULT PARAMETERS

The level indicator parameters can be re-initialised to their factory settings (*Factory parameters*). Section 12 on page 63 describes the procedure for re-initialising the parameters to their factory settings. The factory parameters are described in section 12.5 on page 66.

5.6 FRAME OF MODBUS SIGNAL/RS485



This data is uniquely applicable to all type NH102886 indicators in the configuration with the RS485 cabinet.

The RS485 ModBus connection from the indicator is a signal for transmitting data under the ModBus/Jbus protocol that enables communication in both directions between computer equipment and the controlled level indicator or the temperature indicator.

Some of the values (level, alarm etc.) can be read on the indicator, others (alarm level, ModBus address) can be written.

These addresses are in the following groups:

- Proportional values,
- Logical values.
- Parameter values (speed [1200, 2400, 4800, 9600, 19200 baud], no parity, 8 data bits, 1 stop bit).

5. Description

Address	DATA	VALUES	
00	Free		
Proportional values (interface output)			
01	Nitrogen level reading (%)	0 to 100	248: not in use OR 255: error
02	Temperature reading 1	0 to 100	248: not in use OR 255: error
03	Temperature reading 2 (*)	0 to 100	248: not in use OR 255: error
Logical values (interface output)			
04	Level probe connection correct	00: connection OK	255: fault
05	Indicator low level	00: not reached	255: reached
06	High level alarm	00: not reached	255: reached
07	Low level alarm	00: not reached	255: reached
08	Solenoid valve command status	00: valve not energized	255: valve energized
09	Position of cover (*)	00: cover closed	255: cover open
10	Overflow protection status (*)	00: OK	255: overflow detected
11	Auto top-up with min. threshold information	00: no	255: automatic top-up
12	Temperature probe 1 connection	00: OK	255: fault
13	High temperature alarm 1	00: OK	255: reached
14	Temperature probe 2 connection (*)	00: OK	255: fault
15	High temperature alarm 2 (*)	00: OK	255: reached
Logical values (interface input)			
16	Activation or stoppage of monitored top-up	00: no action 1 to 254: de-energize solenoid valve	255: actuate valve

NOTE: address 16 is the only address permitted to have a number at terminal 000 ("Broadcast")

Parameter values			
17	Upper control threshold	0 to 100	
18	Lower control threshold	0 to 100	
19	High level alarm	0 to 100	
20	Low level alarm	0 to 100	
21	Temperature alarm 1 (*)	0 to 100	
22	Temperature alarm 2 (*)	0 to 100	
23	Write word for addresses 17 to 22	0/255	
24	Thermometer 2 present (*)	00: no	255: Yes
25	Solenoid valve controlled by thermometer 1	00: no	255: Yes
26	Solenoid valve controlled by thermometer 2 (*)	00: no	255: Yes
27	ModBus address	1 to 254	
28	Data transmission rate	00 = 1200 01 = 2400 02 = 4800 03 = 9600 04 = 19200	
29	Write word for addresses 17 to 28	0/255	
30	Free		
31	Free		

(*) These addresses are not used (they are used by the RS485 cabinet with model NH99076)

6. The display

The indicator has an alphanumeric LCD display. It shows different information on starting up, during normal operation or during parameter setting.



Section 20.1 on page 111 summarizes all the information given in this section.

The displays are concise messages in English. They are listed in sections 6.3 and 6.4 on pages 36 onwards.

6.1 LEVEL INDICATOR

6.1.1 On starting up

The Air Liquide logo appears for approximately four seconds while the internal electronics of the indicator initialise.

Figure 6-1:
The display
on power-up.



6.1.2 During normal operation

A bar shows the level in the tank. The graduations start at 10 and go up in steps of 10%.

Figure 6-2:
The level
display.

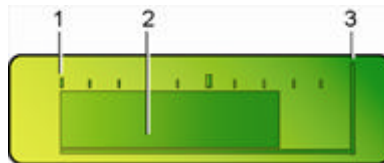

No	Function
1.	0% level mark
2.	Level indicator.

No	Function
3.	100% level mark

6.1.3 Nitrogen level alarm

If the buzzer sounds, the alarm lamp (Figure 5-1: Front panel of the indicator.

, no. 5) lights up and an arrow is displayed at the right-hand end of the level bar, thirty (30) seconds after a level measurement that is:

- either below the programmed threshold LLA :
- or at or above the programmed alarm level HLA .

Figure 6-3: An arrow is displayed if there is a low level (↓) or high level (↑) alarm.

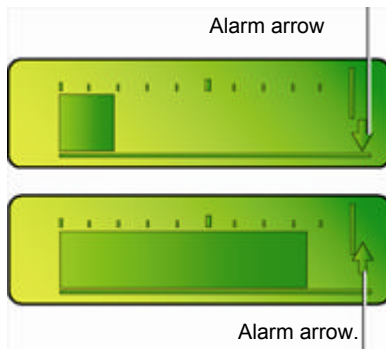

If there is an alarm, pressing on the  button acknowledges (stops) the buzzer. However, the alarm relay output (see section 5.2.3 on page 21) remains energised all the time that the alarm condition exists.

The pictogram and the alarm disappear automatically as soon as the level is definitely above the programmed level LLA or definitely lower than UCL .



The alarm is triggered approximately 30 seconds after the level moves beyond the limit so as to prevent false alarms.

6.1.4 Faults

The display indicates the presence of faults as described below:

- Level probe fault : Err PROBE (probe disconnected or faulty).
- Level probe measurement out of range: display is Err Measure (if the level is below 0 % or above 106 %).

Figure 6-4:
The fault is
displayed.



In all cases if an `Internal error` (equipment problem) is detected, the relay(s) revert(s) to the de-energized state.

If there is a fault, pressing on the  button acknowledges (stops) the buzzer. The fault will remain on the display for as long as it persists and will only disappear when normal measurement is restored.

The list of fault messages is dealt with in section 22 on page 119.

6.1.5 Display showing the current parameter settings of the indicator

Holding the  and  buttons down together displays:

- the operating mode of the indicator on the top line, namely
 - `LEVEL`: indicator without level control
 - `CTRL LEVEL L`: indicator with level control.
 - `TEMP/CTRL LEVEL L`: temperature indicator and indicator with level control.
- Alarm and/or control threshold information, depending on the type of indicator. See paragraph 10.3 on page 55, “stage 3”.

Figure 6-5:
Example of is
display.



6.1.6 While setting parameters

The menus available while setting parameters are given in section 8 on page 47.

6.2 TEMPERATURE INDICATOR

6.2.1 On starting up

The *Air Liquide* logo appears for approximately four seconds while the internal electronics of the indicator initialise.

Figure 6-6:
The display
on power-up.



6.2.2 During normal operation

A bar indicates the temperature inside the storage tank in degrees Celsius or Fahrenheit, depending on the parameter settings (see section 15.3 on page 78).

Figure 6-7:
The
temperature
display.

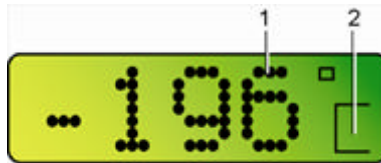

No.	Function	No.	Function
1.	Temperature display.	2.	Unit (°C or °F).

6.2.3 High temperature alarm

Thirty (30) seconds after the temperature measurement has risen above the programmed alarm level (temperature at or above the programmed threshold HTA), the buzzer is activated, the alarm lamp (Figure 5-1: Front panel of the indicator.

no. 5) lights up and an arrow is displayed at the right-hand end of the level bar.

Figure 6-8: An
arrow is
displayed
when there is
a high
temperature
alarm.

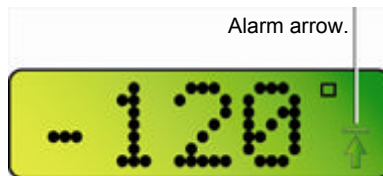

If there is an alarm, pressing on the  button acknowledges (stops) the audible alarm. However, the alarm relay output (see section 5.2.3 on page 21) remains energised all the time that the temperature alarm condition exists. The alarm arrow is automatically erased as soon as the alarm condition disappears.

Once the temperature is definitely below the programmed threshold HTA, the alarm pictogram is automatically erased.



The alarm is triggered approximately 30 seconds after the level moves beyond the limit so as to prevent false alarms.

6.2.4 Faults

The display immediately shows that a fault has occurred, as follows:

- Temperature probe fault : Err PROBE (probe disconnected or faulty).
- Temperature probe measurement out of range: display is Err Measure (if the level is below -200°C or above $+50^{\circ}\text{C}$).
- Fault in the electronic part of the temperature measurement: display shows Internal Err.

Figure 6-9:
The fault is displayed.



If there is a fault, pressing on the  button acknowledges (stops) the buzzer. The fault will remain on the display for as long as it persists and will only disappear when normal measurement is restored.

The fault messages are listed in Section 22 on page 119.

6.2.5 Displaying the current parameter settings of the indicator

Holding the  and  buttons down together displays:

- the operating mode of the indicator, namely Temperature = temperature indicator.

- The high level alarm (HTA : *High Temperature Alarm*) in °C or °F depending on how it is programmed (refer to section 10.3 on page 55 “stage 3”).

Figure 6-10 :
Temperature
indicator with
an alarm set
to -130°C



6.2.6 While setting parameters

See section 8 on page 47 for the parameter setting menus that are available.



Section 6.3 on page 36 explains the abbreviations used (HLA, LCL, etc.).

6.3 SYMBOLS USED

The following table lists the abbreviations displayed on the screens and the graphics used in section 7 on page 39 and explains them.

Symbol	Description (action by the indicator)
°C	Temperature in degrees Celsius.
°F	Temperature in degrees Fahrenheit.
HLA	High Level Alarm (triggers the alarm lamp and the buzzer. The high level threshold has been reached).
LCL	Lower Control Level (activates the relay).
UCL	Upper Control Level (activates the relay).
LLA	Low Level Alarm (triggers the alarm lamp and the buzzer. The low level threshold has been reached).
HTA	High Temperature Alarm (triggers the alarm lamp and the buzzer. The high temperature threshold has been reached).

6.4 TEXTS DISPLAYED

The table below lists the texts that are displayed on the various types of indicator.

Text
CALIBRATION
CONTROLLED LEVEL
DATA TRANSF. RATE
EMPTY
FACTORY PARAMET.
FAHRENHEIT DISP.
FULL
GASEOUS
HIGH LEVEL ALARM
KEY
LEVEL
LEVEL PARAMETERS
LOW LEVEL ALARM
LOWER CTRL LEVEL
MODBUS ADDRESS
NO
PARAMET. DISPLAY
PARAMET. STORAGE
PARAMETERS ERROR
SIMPLE LEVEL
TEMP. PARAMETERS
TEMPERATURE
TEMPERATURE ALARM
UPPER CTRL LEVEL
YES

7. Operating graphics:

This section describes the graphics for the indicator operating cycles.

7.1 THRESHOLDS ON THE STORAGE TANK

The figure and table below show the connection between the alarm thresholds and the levels of the indicators, and their physical locations on a storage tank.

Figure 7-1:
Physical location of the alarm and level thresholds on a storage tank.

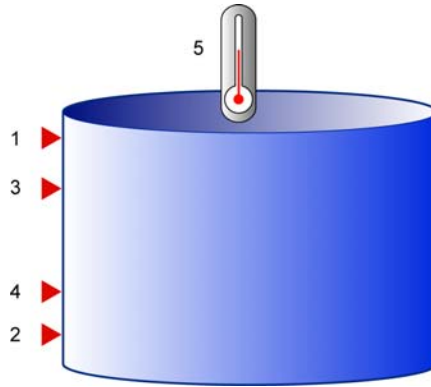

No.	Symbol	Description
1.	HLA	High Level Alarm
2.	LLA	Low Level Alarm
3.	UCL	Upper Control Level
4.	LCL	Lower Control Level
5.	HTA	High Temperature Alarm

7.2 GRAPHICS DURING OPERATION

The following graphics show the position of the different alarm thresholds for the temperature and level indicators, with and without level control.

7.2.1 Temperature indicator

Figure 7-2: The operating cycle of the temperature indicator in °C.

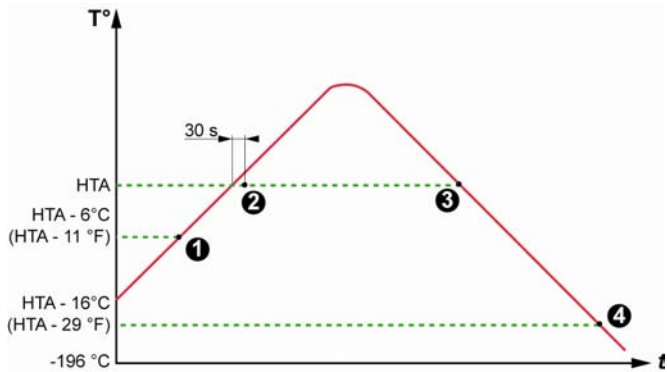

No.	Meaning
1.	Activation of the level compensation relay: Contacts 4-5 open. Contacts 4-6 close.
2.	Activation of the audible and visual alarms (buzzer and LED). ↑ pictogram is displayed. Alarm relay: Contacts 7-9 open Contacts 7-8 close.

No.	Meaning
3.	De-activation of the audible and visual alarms (buzzer and LED). ↑ pictogram disappears. Alarm relay: Contacts 7-8 open. Contacts 7-9 close.
4.	De-activation of the level compensation relay: Contacts 4-6 open. Contacts 4-5 close.

7.2.2 Level indicator

7.2.2.1 Level only

This illustration refers to types NH102885-N and NH102886-N.

Figure 7-3: The operating cycle of the "level only" indicator.

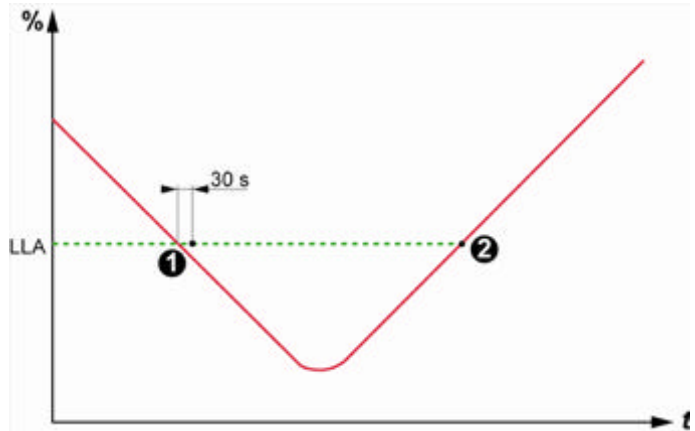

No.	Meaning
1.	Activation of the audible and visual alarms (buzzer and LED) ↓ pictogram is displayed. Alarm relay: Contacts 7-9 open Contacts 7-8 close.

No.	Meaning
2.	De-activation of the audible and visual alarms (buzzer and LED). ↓ pictogram disappears. Alarm relay: Contacts 7-8 open Contacts 7-9 close.

7.2.3 Controlled level

This illustration refers to indicators with controlled liquid or gas level (see page 7).

Figure 7-4: The operating cycle of the controlled (liquid or gas) level indicator.

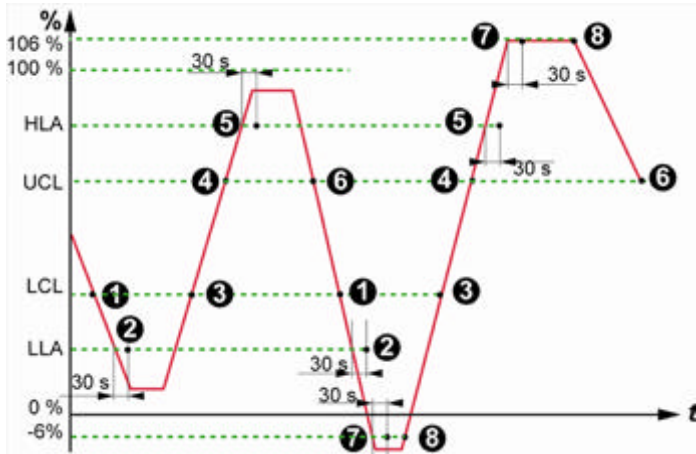

7. Operating cycle

No.	Meaning
1.	Activation of the filling valve control relay.
2.	Activation of the audible and visual alarms (buzzer and LED). ↓ pictogram is displayed. Alarm relay: Contacts 7-9 open Contacts 7-8 close.
3.	De-activation of the audible and visual alarms (buzzer and LED). ↓ pictogram is displayed. Alarm relay: Contacts 7-8 open Contacts 7-9 close.
4.	De-activation of the filling valve control relay.

No.	Meaning
5.	Activation of the audible and visual alarms (buzzer and LED). Alarm relay: Contacts 7-9 open Contacts 7-8 close.
6.	De-activation of the audible and visual alarms (buzzer and LED). ↑ pictogram disappears. Alarm relay: Contacts 7-8 open Contacts 7-9 close.
7.	De-activation of the filling valve control relay. ERR MEASURE is displayed. Alarm relay is activated: Contacts 7-9 open Contacts 7-8 close.

Menu

8. General notes

This section describes the menus that can be accessed on the different indicator versions.

8.1 COMPARISON OF THE MENUS

All the different indicator menus have a common main menu made up of identical submenus. Their functions and use are thus identical.

The specific submenus are for setting the temperature or level alarm thresholds.

The following two pages describe the menus and main submenus that are available for the various indicator versions.

Menu type	Code	Function	See
1	NH102885-N	Level without control	Figure 8-1
2	NH102885-T	Temperature	Figure 8-2
1	NH102886-N	Level without control	Figure 8-1
2	NH102886-T	Temperature	Figure 8-2
3	NH102886-NRG	Level with gas level control	Figure 8-3
3	NH102886-NRL	Level with liquid level control	Figure 8-3
4	NH102886-TNG	Temperature and level with gas level control	Figure 8-4
4	NH102886-TNL	Temperature and level with liquid level control	Figure 8-4

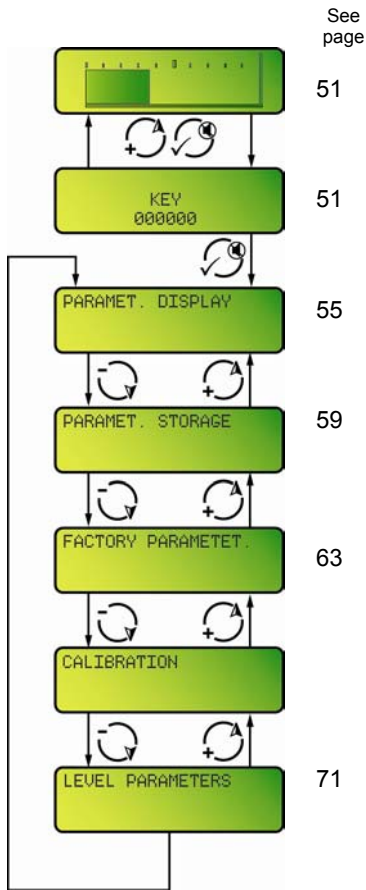

Figure 8-1:

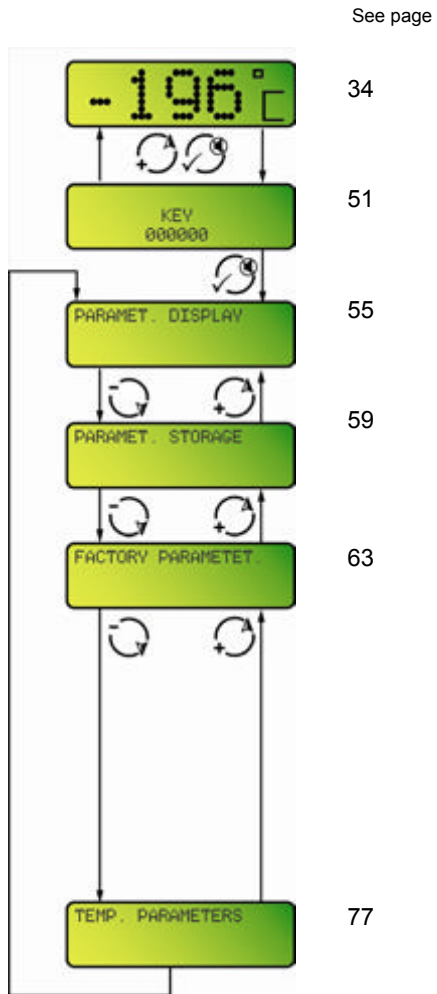

Figure 8-2:

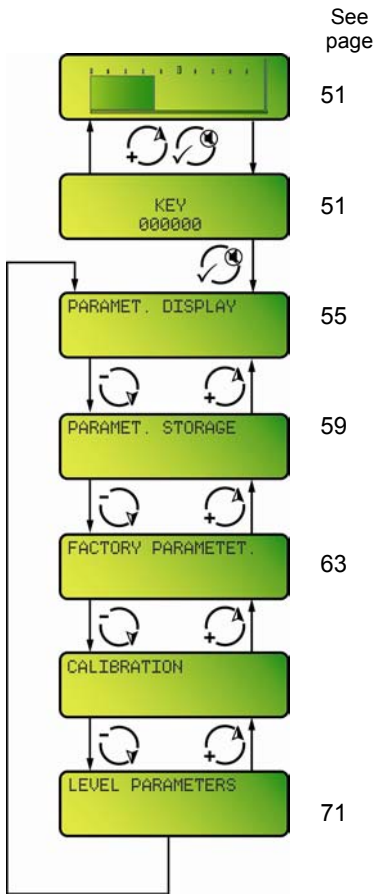

Figure 8-3:

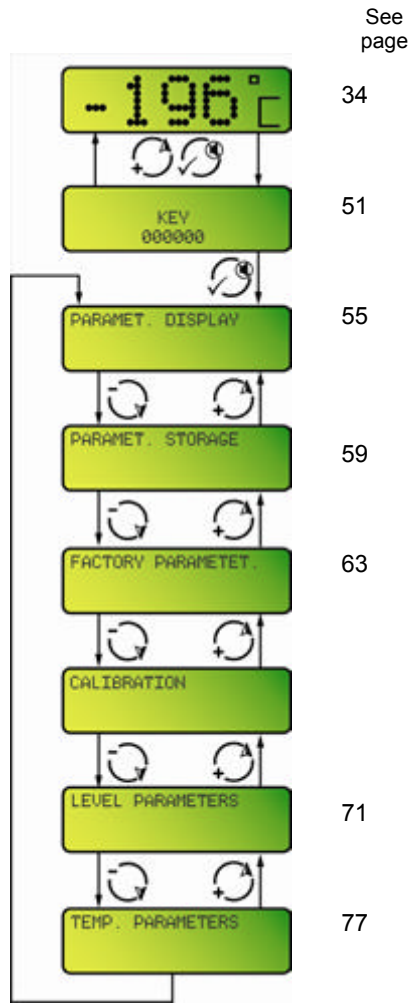

Figure 8-4:

9. The “Key” menu

This menu enables an access code to be entered. The indicator menus cannot be navigated without an access code (see pages 48 and 49).





The user cannot change the access code.



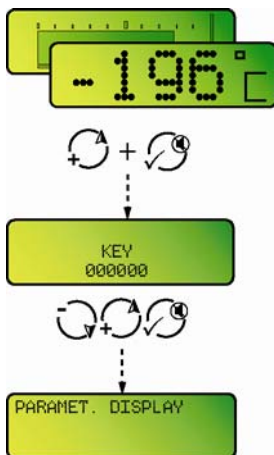

9.1 MENU DIAGRAM

Figure 9-1: :
The “Key”
menu.

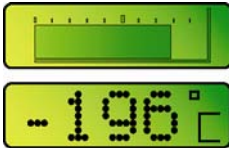

9.2 ACCESSING THE MENU

Press the  and  buttons simultaneously. Proceed as follows:

Step	Display	Button	Action or result
1.			Depending on its type, the indicator displays the level graphic or the temperature.
2.		 	Press these two buttons simultaneously for about 3 seconds.
3.			The display darkens, then comes on again blank. Release the buttons.
4.			The Key menu appears. Continue to the next section (below).

9.3 ENTERING THE CODE

The code can be obtained from the sales team. It consists of 6 figures and cannot be changed by the user. The code is entered in two stages:









- first the 3 figures at the left-hand end of the code,
- then the 3 figures at the right-hand end of the code,

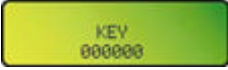

You can only do this if you have authorisation and you know the specific password that is required. The password is supplied with this manual.

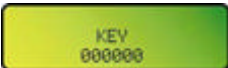
If no action is taken for 30 seconds the indicator will re-initialise automatically and its existing parameters will remain unchanged.

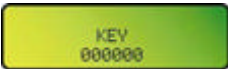
Proceed as follows:

Step	Display	Button	Action or result
1.			The indicator displays the <code>Key</code> menu.
2.			Enter the first 3 figures of the code, starting at the left, by depressing this button once.
3.			Confirms this figure.
4.			Enter the last 3 figures of the code by depressing this button twice.
5.			Confirms this figure.
6.			The <code>PARAMET. DISPLAY</code> menu appears.

9.4 LEAVING THE “KEY” MENU

The “Key” menu shuts down:

- If the `Parameters storage` menu (see page 59) is used to save any changes that have been made.
- If no keys have been pressed for approx. 30 seconds. In this case any changes that have been made are disregarded.

10. The “Paramet. Display” menu

This menu displays the threshold parameters that have been programmed by the user. The information displayed depends on the type of indicator (see section 4.2 on page 12). Pages 48 and 49 show the branching structure of the menus.



This display is similar to the one obtained by pressing on buttons  simultaneously (see 6.2.5 on page 35).

10.1 MENU DIAGRAM

Figure 10-1: The “Paramet. Display” menu.

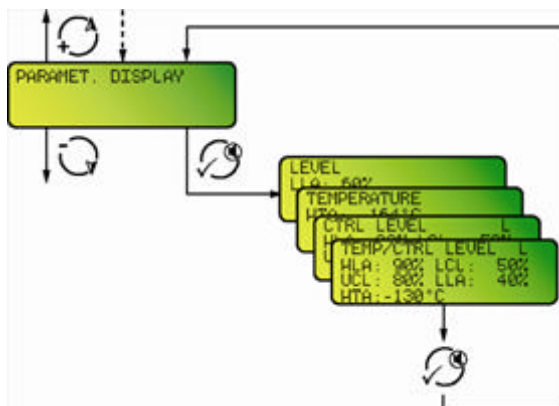





10.2 ACCESSING THE MENU

The access code must be entered to access this menu. Follow the instructions given in sections 9.2 and 9.3, page 521 onwards.

10.3 USING THE MENU

Proceed as follows:

Step	Display	Button	Action or result
1.			The PARAMET. DISPLAY menu is displayed.
2.			Confirms this selection.
3.			The display offers the current threshold parameters for the type of indicator concerned.
			<p>Temperature indicator</p> <p>HTA standing for <i>High Temperature Alarm</i>. A temperature measurement that is above this threshold activates the audible and visual alarms.</p>
			<p>Level indicator without control</p> <p>LLA standing for <i>Low Level Alarm</i>. A level measurement that is below this threshold activates the audible and visual alarms.</p>
			<p>Controlled level indicator (see illustrations in section 7.2 on page 40).</p> <p>LLA - <i>Low Level Alarm</i>. (A level measurement that is below this threshold activates the audible and visual alarms.)</p> <p>LCL - <i>Lower Control Level</i>. A level measurement that is below this threshold activates topping-up with nitrogen.</p> <p>UCL - <i>Upper Control Level</i>. A level measurement that is above this threshold stops topping-up with nitrogen.</p> <p>HLA - <i>High Level Alarm</i>. A level measurement that is above this threshold activates the audible and visual alarms.</p>



Temperature and controlled level indicator

The displays HLA, LCL, UCL and LLA are the same as those for the controlled level indicator (see above).

HTA stands for *High Temperature Alarm*. A temperature measurement that is above this threshold activates the audible and visual alarms.

10.4 LEAVING THE "PARAMET. DISPLAY" MENU

The `Paramet. Display` menu can be shut down:

- By using the `Parameter storage` menu (see page 59) to save any changes that have been made.
- If no keys have been pressed for approx. 30 seconds. In this case any changes that have been made are disregarded.

11. The “Paramet. Storage” menu

This menu allows the user to change parameters and apply them.

11.1 MENU DIAGRAM

Figure 11-1: The “Paramet. Storage” menu.

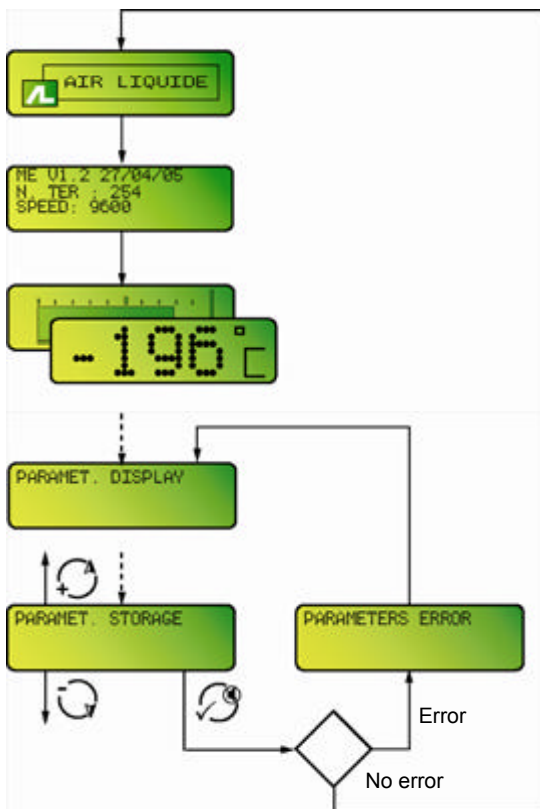











11.2 ACCESSING THE MENU

The access code must be entered to access this menu. Follow the instructions given in sections 9.2 and 9.3, page 51 onwards.

11.3 USING THE MENU

Proceed as follows:

Step	Display	Button	Action or result
1.			With the PARAMET. DISPLAY menu displayed, press this button once to display the PARAMET. STORAGE screen.
2.			Confirms the new parameters. After confirmation, the indicator shuts down and restarts. If you wish to ignore the changes that have been made and return to the measurement screen without re-initialising, wait for 30 seconds without touching any of the buttons.
4.			The PARAMET. DISPLAY menu is displayed The parameters are automatically checked.
			If the parameters are correct, they are stored in the indicator's memory. The indicator then reverts to the measurement and display mode and the new parameters are active.
			
			If the parameters are not correct, pressing "confirm" causes PARAMETERS ERROR to be displayed. If this happens, press  to close this screen and return automatically to the PARAMET. DISPLAY screen: the old parameters will still be valid. The parameters then need to be changed again, keeping to the permitted values.

11.4 LEAVING THE MENU

The `PARAMET.STORAGE` menu can be shut down:

- By pressing the  button.
- If no keys have been pressed for approx. 30 seconds. In this case any changes that have been made are disregarded.

12. The “Factory Paramet. menu”

This menu enables the indicator to be reinitialised with the factory parameters (see section 12.5 on page 66), i.e. the settings it had when delivered.

12.1 MENU DIAGRAM

Figure 12-1:
The “Factory
Paramet.”
menu.

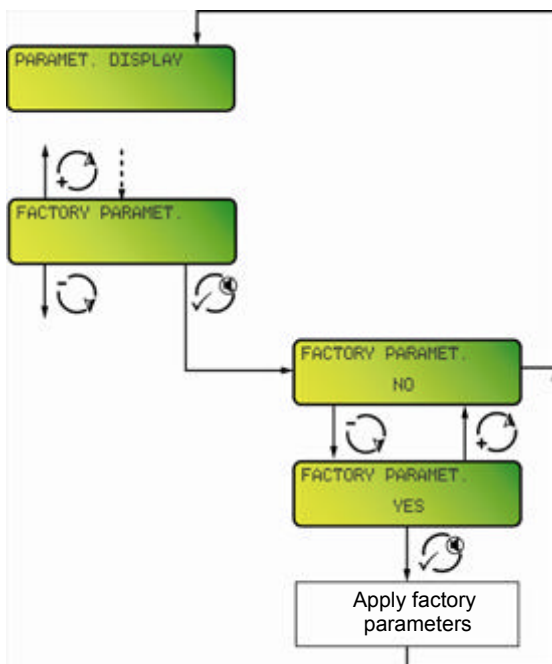

12.2 ACCESSING THE MENU











The access code must be entered to access this menu. Follow the instructions given in sections 9.2 and 9.3, page 51 onwards.

12.3 USING THE MENU

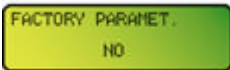
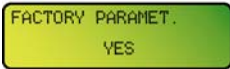

This procedure re-initialises all the alarm parameters and the control thresholds to the predefined (default) values. Nevertheless, the calibration values (section 13 on page 67) remain unchanged.

Proceed as follows:

Step	Display	Button	Action or result
1.			The <code>PARAMET. DISPLAY</code> menu is displayed
2.		2x 	Press twice.
3.			The <code>FACTORY PARAMET.</code> menu is displayed.
			Enter the <code>FACTORY PARAMET.</code> menu.
			The measurement screen reappears after 30 seconds if no buttons are pressed.
4.			The display reads <code>NO</code> .
5.		  	Reinitialise the indicator with the factory parameters. The display reads <code>YES</code> . Section 12.5 on page 66 lists the factory parameters (default parameters).
			After 30 seconds of inactivity, parameter setting is abandoned without reinitialising and the measurement screen returns.
6.			Reinitialise the indicator.
7.			The <code>PARAMET. DISPLAY</code> menu is displayed if <code>NO</code> has been confirmed.

12. The “Factory Paramet.” menu



8.



At this stage the indicator is ready to be reinitialised with its factory parameters, but the action has not yet been confirmed.

You **MUST** proceed to paragraph 11.3 on page 60.



Reminder: once stage no. 8 has been confirmed, the factory parameters can also be displayed from the measurement screen by pressing the  and  buttons simultaneously (see section 12.5 on page 66).

12.4 LEAVING THE “FACTORY PARAMET.” MENU

Once the `FACTORY PARAMET.` menu has been conformed, the indicator displays the `PARAMET. DISPLAY` menu. To leave this menu:

- Use the `Parameter storage` menu (see page 59) to save any changes that have been made.
- If no keys have been pressed for approx. 30 seconds. In this case any changes that have been made are disregarded.

12.5 FACTORY PARAMETERS



Section 6.3 on page 36 explains the abbreviations used (HLA, LCL, etc.).

12.5.1 Level indicators.

Display	Level only	Level with control	
	NH102885-N NH102886-N	NH102886-NRL	NH102886-NRG
HLA		90%	95%
LCL		50%	40%
UCL		80%	80%
LLA	40%	40%	25%
ModBus (*)		254	254
Rate(*)		9600	9600

Only applicable to models with an RS485 connector (type NH102886-x)

12.5.2 Controlled temperature and level indicators

Display	Temperature	Temperature and controlled level	
	NH102885-T NH102886-T	NH102886-TNL	NH102886-TNG
HLA		90%	95%
LCL		50%	40%
UCL		80%	80%
LLA		40%	25%
HTA	-130 °C	-130 °C	-130 °C
Temperature	Units (°C)	Units (°C)	Units (°C)
ModBus (*)		254	254
Rate(*)		9600	9600

Only applicable to models with an RS485 connector (type NH102886-x)

13. The “Calibration” menu

Use this menu to calibrate the values 0% [EMPTY] and/or 100% [FULL] on the gauge.

13.1 MENU DIAGRAM

Figure 13-1: :
Diagram of the
“Calibration”
menu.

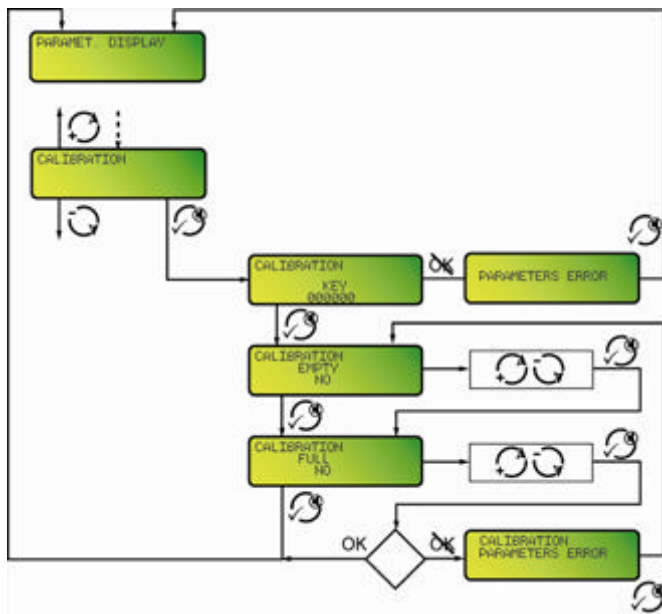













13.2 ACCESSING THE MENU





This menu is accessed after entering the access code. This code can be obtained from the sales team. Follow the instructions given in sections 9.2 and 9.3, page 51 onwards.

13.3 USING THE MENU

Proceed as follows:

Step	Display	Button	Action or result
1.			The PARAMET. DISPLAY menu is displayed.
2.			Press  a number of times until the CALIBRATION menu is displayed.
3.			The indicator displays the CALIBRATION menu.
4.			Confirm this selection.
5.			Enter the access code (see page 51).
6.			Confirm this figure.
7.			The display shows this message.
8.			Setting the 0% (empty) level of the tank.
9.			Check that the tank is actually empty and the gauge is properly located and connected to the level indicator.
10.			Press one of the two buttons to display YES.
11.			Confirm this selection.
12.			Setting the 100% (full) level of the tank.
13.			The display shows this message.
14.			Fill the tank with liquid nitrogen up to maximum capacity (follow the storage tank instructions on using the rule to find the 100% position).

13. The “Calibration” menu

15.		Once the 100% level has been reached, wait at least 5 minutes for the level to stabilise.
16.		 Press one of the two buttons to display YES.
17.		 Confirm this selection.
18.		After confirmation the calibration values are checked. <ul style="list-style-type: none">- If the indicator detects inconsistent values (Parameter error) the display reverts to the CALIBRATION EMPTY screen. The calibration operation must be repeated from step 9 of this section onwards until the values are consistent.
		<ul style="list-style-type: none">- If the values are consistent, the calibration values are stored. The PARAMET. DISPLAY menu is then displayed.
		At this stage the indicator is ready to be reinitialised, but the action has not yet been confirmed. You MUST proceed to paragraph 11.3 on page 60.

13.4 LEAVING THE “CALIBRATION” MENU

To exit the “CALIBRATION” menu:

- Use the Parameter storage menu (see page 59) to save the new calibration.
- If no keys have been pressed for approx. 30 seconds. In this case the new calibration is disregarded.

14. The “Level Paramet” menu

This menu is used to set the level alarms LLA and HLA, the level thresholds LCL and UCL, the ModBus address and the data transfer rate.

14.1 MENU DIAGRAM

Figure 14-1:
Diagram of the
“Level
Paramet.”
menu.

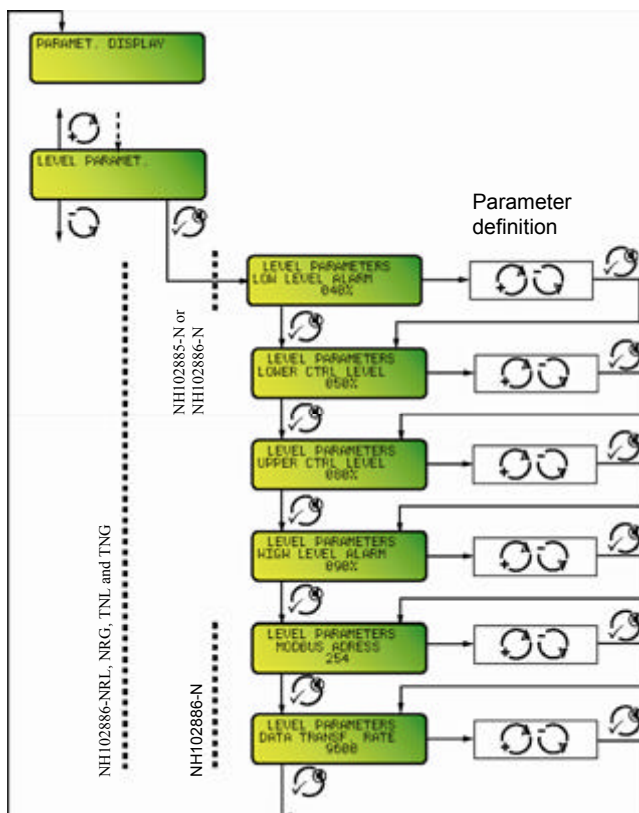

14.2 ACCESSING THE MENU







This menu is accessed after entering the access code. Follow the instructions given in sections 9.2 and 9.3, page 51 onwards.

14.3 USING THE MENU



Proceed as follows:











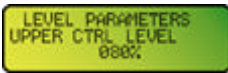



The menus displayed depend on the indicator type.
See paragraph 12.5 on page 66 for the default parameters.

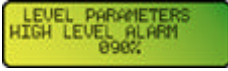

















Step	Display	Button	Action or result
1.			The <code>PARAMET. DISPLAY</code> menu is displayed.
2.			Press one of these buttons a number of times until you see the <code>LEVEL PARAMETERS</code> menu.
3.			The <code>LEVEL PARAMETERS</code> menu is displayed.
			Enter this menu.
			Return to the measurement screen after 30 seconds if no buttons are pressed.
			On models NH102885-N and NH102886-N, it is only possible to set the <code>LLA</code> threshold.
4.			This message appears on the display.

14. The “Level Parameters” menu

Step	Display	Button	Action or result	
5.			Setting the low level alarm threshold [LLA] (described on page 40)	
			Does not change the current alarm threshold.	
				Changes the alarm threshold display (permitted range 5% to 75%)
				- reduces the displayed value.
				- increases the displayed value.
				Confirms the new alarm threshold.
			For indicators with level control, the value of [LLA] must be: $5\% \leq [LLA]$; $[LLA] \leq [LCL] - 5\%$.	
6.			Setting the lower control level [LCL] (described on page 40).	
			Does not change the current lower control level.	
				Changes the lower control threshold displayed (range 10% to 80%)
				- reduces the displayed value.
				- increases the displayed value.
				Confirms the new lower control level.
			For indicators with level control, the value of [LLA] must be: $10\% \leq [LCL] \leq 80\%$; $[LCL] \leq [UCL] - 10\%$.	

Step	Display	Button	Action or result
7.			Setting the upper control level [UCL] (described on page 40).
			Does not change the current control level.
			Changes the upper control threshold displayed (range 20% to 90%)
			- reduces the displayed value.
			- increases the displayed value.
			Confirms the new upper control level.
			For indicators with level control, the value of [UCL] must be: $20\% \leq [UCL] \leq 90\%$; $[UCL] \geq [LCL] + 10\%$.
8.			Setting the high level alarm [HLA]] (described on page 40).
			Does not change the current alarm threshold.
			Changes the alarm threshold display (range 25% to 95%)
			- reduces the displayed value.
			- increases the displayed value.
			Confirms the new alarm threshold.
			For indicators with level control, the value of [HLA] must be: $25\% \leq [HLA] \leq 95\%$; $[HLA] \geq [UCL] + 5\%$

14. The “Level Parameters” menu

Step	Display	Button	Action or result	
9.			Setting the ModBus address	
			Does not change the current address.	
			 	Changes the logical address displayed on the indicator (range 1 to 254 on a single network)
				<i>The indicator does not check this parameter.</i>
				- reduces the displayed value.
				- increases the displayed value.
				Confirms the new ModBus address.
10.			Setting the RS485 transmission rate	
			Leaves the current rate unchanged.	
			 	Changes the displayed transmission rate (possible values 1200, 2400, 4800, 9600 and 19200 baud).
				This is the rate at which the data is transmitted between the level indicator and the master. The level indicator and the master must be set to the same rate. <i>The indicator does not check this parameter.</i>
				- reduces the displayed value.
				- increases the displayed value.
11.			The PARAMET. DISPLAY menu is displayed.	
			12.	

14.4 LEAVING THE “LEVEL PARAMET.” MENU

To exit the `LEVEL PARAMET.` menu:

- Use the `Parameter storage` menu (see page 59) to save any changes that have been made.
- If no keys have been pressed for approx. 30 seconds. In this case any changes that have been made are disregarded.

15. The “Temp. Parameters” menu

This menu is used to set the units of the temperature display and the high temperature alarm [HTA], the ModBus address and the transmission rate.

15.1 MENU DIAGRAM

Figure 15-1:
Diagram of the
“Temp.
Parameters”
menu.

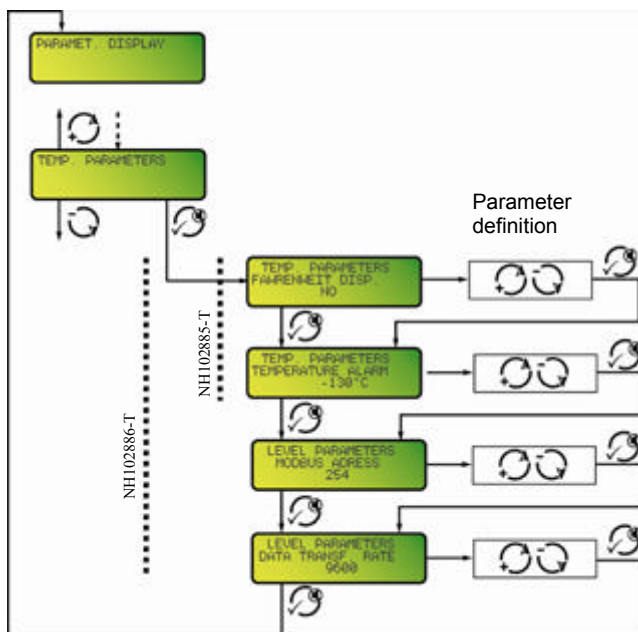











15.2 ACCESSING THE MENU











This menu is accessed after entering the access code. Follow the instructions given in sections 9.2 and 9.3, page 51 onwards.









15.3 USING THE MENU

Proceed as follows:

Step	Display	Button	Action or result
1.			The PARAMET. DISPLAY menu is displayed.
2.			Press once only
3.			The TEMP. PARAMETERS menu is displayed.
			Enters this menu.
			Returns to the measurement screen after 30 seconds if no buttons are pressed.
4.			This message appears on the display.
5.			Selecting the display units
			Leaves the current units unchanged (°C or °F).
			Changes the units displayed:
			- if the display is in °C
			Press  (YES is displayed), followed by
			to display °F.
			If no keys have been pressed for approx. 30 seconds, the following screen appears:

15. The “Temp. Parameters” menu

Step	Display	Button	Action or result
6.			Setting the temperature alarm threshold [HTA]
			Does not change the current alarm threshold.
			Changes the alarm threshold display (range 0 to -170 °C or 32 to -274 °F):
			 <i>The temperature alarm threshold can only be set in degrees centigrade. A conversion table for degrees Celsius (centigrade) and Fahrenheit is given in section 15.5 on page 80.</i>
			 - reduces the displayed value in steps of 2°C.
			 - increases the displayed value in steps of 2°C.
7.			Setting the ModBus address
			Does not change the current address.
			To changes the address displayed (range 1 to 254):
			 - reduces the displayed value.
			 - increases the displayed value.
			 Confirms the new ModBus address.
		 <i>When an NH102886-TNL or TNG is used with a Cryoview (NH102887), the ModBus address MUST be set to 1.</i>	

Step	Display	Button	Action or result
8.			Setting the RS485 transmission rate Does not change the current rate.
			Changes the displayed transmission rate (possible values 1200, 2400, 4800, 9600 and 19200 baud).
			- reduces the displayed value.
			- increases the displayed value.
			Confirms the new transmission rate.
9.			The PARAMET. DISPLAY menu is displayed
			Once the parameters have been defined, they can be checked using the PARAMET. DISPLAY menu (section 10, page 55): - If they are correct, proceed to the next step - If they are not correct, re-start the operation from point 1 of this section.
10.			At this stage the parameter settings are in the memory, but the action has not yet been confirmed. You MUST proceed to paragraph 11.3 on page 60.

15.4 LEAVING THE “TEMP. PARAMETERS” MENU

To exit the TEMP. PARAMATERS menu:

- Use the Parameter storage menu (see page 59) to save any changes that have been made.
- If no keys have been pressed for approx. 30 seconds. In this case any changes that have been made are disregarded.

15.5 CONVERSION TABLE CENTIGRADE/FAHRENHEIT

$$^{\circ}\text{C} \rightarrow ^{\circ}\text{F}: \quad T^{\circ}\text{F} = \left(T^{\circ}\text{C} \times \frac{9}{5} \right) + 32$$

$$\text{F} \rightarrow ^{\circ}\text{C}: \quad T^{\circ}\text{C} = \left(T^{\circ}\text{F} - 32 \right) \times \frac{5}{9}$$

$^{\circ}\text{C}$	$^{\circ}\text{F}$
-50	-58
-52	-62
-54	-65
-56	-69
-58	-72
-60	-76
-62	-80
-64	-83
-66	-87
-68	-90
-70	-94
-72	-98
-74	-101
-76	-105
-78	-108
-80	-112
-82	-116
-84	-119
-86	-123
-88	-126

$^{\circ}\text{C}$	$^{\circ}\text{F}$
-90	-130
-92	-134
-94	-137
-96	-141
-98	-144
-100	-148
-102	-152
-104	-155
-106	-159
-108	-162
-110	-166
-112	-170
-114	-173
-116	-177
-118	-180
-120	-184
-122	-188
-124	-191
-126	-195
-128	-198

$^{\circ}\text{C}$	$^{\circ}\text{F}$
-130	-202
-132	-206
-134	-209
-136	-213
-138	-216
-140	-220
-142	-224
-144	-227
-146	-231
-148	-234
-150	-238
-152	-242
-154	-245
-156	-249
-158	-252
-160	-256
-162	-260
-164	-263
-166	-267
-168	-270

Installation

16. Structure of an installation

16.1 THE VARIOUS POSSIBLE CONFIGURATIONS

The four configurations that are generally used are listed in the table below.

Since the temperature and the level are displayed in all the configuration, the optional items are control and traceability of measurements.

Type of configuration	Level control	Measurement output
1	By external unit	4-20 mA or RS485
2	No	RS485
3	Included	RS485 (External Ethernet [A])
4	Included	Integral Ethernet [B]

[A] Ethernet output via *additional Cryolink* unit. *Guaranteed traceability 21CFR, part 11.*

[B] Integral Ethernet. *No 21CFR, part 11 traceability.*

The following paragraphs give details of the various configurations.

16.2 CONFIGURATION 1

This configuration displays the temperature and level. An external unit controls the level.

An independent overflow valve (not shown) is also fitted. The relief valve is optional.

*Figure 16-1:
The
temperature
and level
displays.
Level control
using an
external unit.*

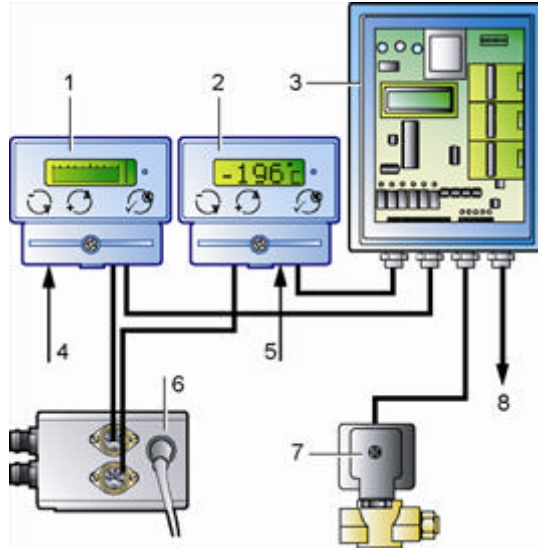

No.	Component	Function
1.	NH102885-N	Level display (no level control)
2.	NH102885-T	Temperature display
3.	External unit	Level control
4.	Level probe	Level measured by capacitance probe.
5.	Temperature probe	Level measured by temperature probe.
6.	Power supply unit	Supply to the indicators.
7.	Solenoid valve	Level control
8.	Output from the external unit	User output (4-20 mA or RS485 depending on version)

16.3 CONFIGURATION 2

This configuration displays the temperature and level. No level control is installed. An optional RS485-Ethernet converter allows traceability to 21CFR, part 11.

An independent overflow valve (not shown) is also fitted. The relief valve is optional.

Figure 16-2:
The
temperature
and level
displays. No
level control.

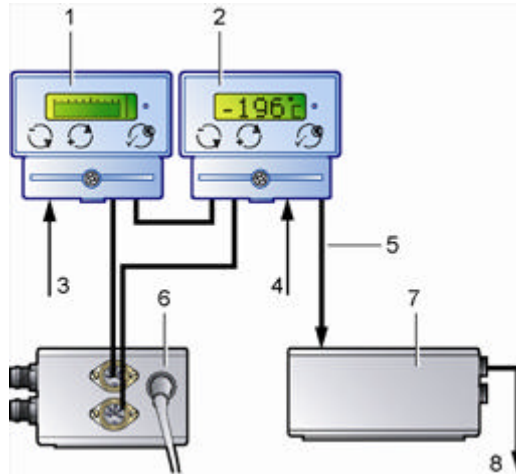

No.	Component	Function
1.	NH102886-N	Level display (no level control)
2.	NH102886-T	Temperature display
3.	Level probe	Level measured by capacitance probe.
4.	Temperature probe	Level measured by temperature probe.
5.	Measurement output	RS485
6.	Power supply unit	Supply to the indicators.
7.	Cryolink	RS485-Ethernet converter (option).
8.	Ethernet network	Transmits measurement in Ethernet format

16.4 CONFIGURATION 3

This configuration displays the temperature and level. The level indicator controls the level. The optional RS485-Ethernet converter does not, however, allow traceability to 21CFR, part 11.

An independent overflow valve (not shown) is also fitted. The relief valve is optional.

Figure 16-3:
The
temperature
and level
displays.
Level
controlled by
the level
indicator.

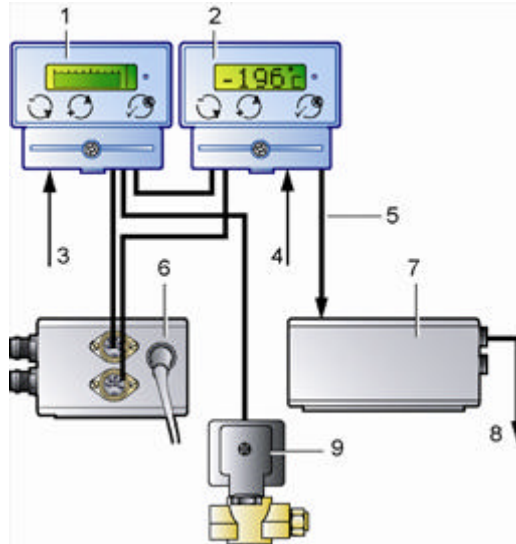

No.	Component	Function
1.	NH102886-NRL or NRG	Level display and level control
2.	NH102886-T	Temperature display
3.	Level probe	Level measured by capacitance probe.
4.	Temperature probe	Level measured by temperature probe.
5.	Measurement output	RS485
6.	Power supply unit	Supply to the indicators.
7.	Cryolink	RS485-Ethernet converter (option).
8.	Ethernet network	Transmits measurement in Ethernet format
9.	Solenoid valve	Level control

16.5 CONFIGURATION 4

This configuration displays the temperature and level. The temperature indicator displays the temperature and controls the level. The level is displayed on the level indicator, which also has an integral Ethernet output; there is no traceability to 21CFR, part 11. An independent overflow valve (not shown) is also fitted. The relief valve is optional.

*Figure 16-4:
Temperature
and level
displays Level
controlled by
the
temperature
indicator.
Integral
Ethernet
output.*

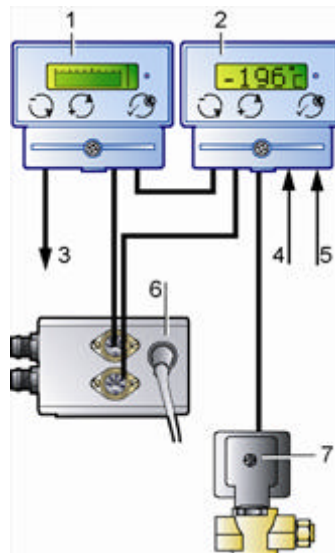

No.	Component	Function
1.	NH102887 Cryoview	Level display.
2.	NH102886-TNL or TNG	Temperature display and level control
3.	Ethernet output	Transmits measurement in Ethernet format
4.	Level probe	Level measured by capacitance probe.
5.	Temperature probe	Level measured by temperature probe.
6.	Power supply unit	Supply to the indicators.
7.	Solenoid valve	Level control

17. Mechanical installation

As a general rule the level or temperature indicator is supplied mounted on a storage tank when the latter is delivered. However, where an old indicator is to be replaced with this new model, this section gives details of the mechanical operations required. **If a new indicator is not being fitted, the existing one should be returned to the manufacturer for reprogramming.**

17.1 REPLACING AN OLD INDICATOR

17.1.1 On a type *Espace* faired storage tank

Proceed as follows:

1. Remove the 4 fixing screws (Figure 17-1: Fitting stages on a faired *Espace* tank.

, item 2) from the lid of the tank.

*Figure 17-1:
Fitting stages
on a faired
Espace tank.*

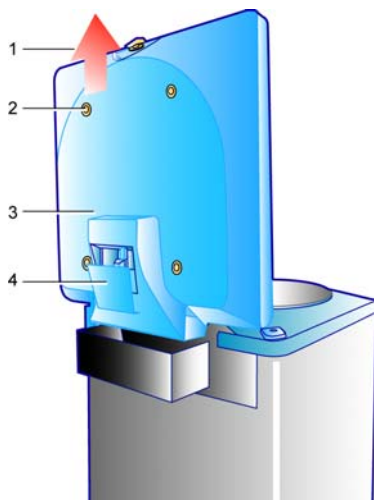

2. Bring the protective plastic cover (3) into a vertical position. Lift it upwards (1), remove it and put it in a safe place. This lid should be replaced as soon as possible to maintain the low temperature in the tank.
3. Close the lid (3) again and place a weight of approx. 1 kg on it to prevent it opening by itself.
4. Remove the 2 screws securing the protective cap (4) and remove the cap.
5. Disconnect the wires of the old indicator and remove it.
6. Slide the new indicator onto its fixing lug.
7. Connect the wires as shown in Section 18 on page 95.
8. Reposition the protective cap and cover (4 and 3) and secure them with their respective screws.

17.1.2 On a type *Espace* storage tank without fairing

1. Remove the 2 fixing screws (no. 1) and lift off the protective cover (no. 2).

*Figure 17-2:
Fitting stages
on an Espace
tank without
fairing.*

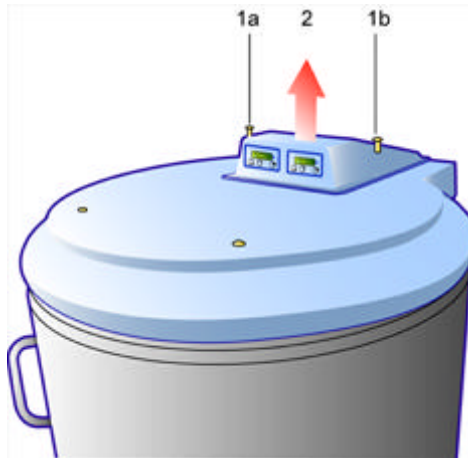

2. Disconnect the wires of the old indicator and remove it.
3. Slide the new indicator onto its fixing lug.
4. Connect the wires as shown in Section 18 on page 95.
5. Reposition the protective cover and secure it with the 2 screws (no. 1).

17.1.3 On a type *Arpège* storage tank

Proceed as follows:

1. Remove the 3 securing screws (no. 1), 2 at the front and 1 at the rear.
2. Pull the protective cover (no. 2) upwards and remove it.
3. There are two possible situations:
 - *If both indicators are the old type*: pull the old indicators upwards and remove them. Disconnect the wiring. Position each new indicator on its fixing lug.
 - *If only the level indicator needs to be replaced*: pull the old indicator upwards and remove it. Disconnect the wiring, then position the new indicator on its fixing lug.
4. Connect the wires as shown in Section 18 on page 95.
5. Reposition the plastic profile and secure with the 3 screws.

*Figure 17-3:
Fitting stages
on an *Arpège*
tank.*

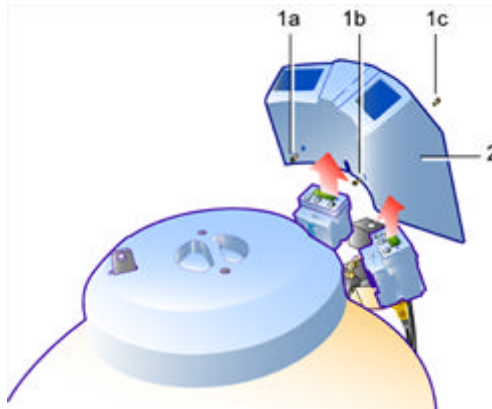

17.1.4 On a type RCB storage tank

1. Disconnect the wires (1) of the old indicator (2) and remove it.
2. Remove the front securing screw (3) and the front plate (4).
3. Slide the indicator towards the rear (6) to disengage it from its fixing lug (5).
4. Slide (7) the new indicator onto the fixing lug (5) and replace the front plate (4) and the securing screw (3).
5. Connect the wires as shown in Section 18 on page 95.

*Figure 17-4:
Steps for
removing the
plastic cover
from an RCB
type tank.*

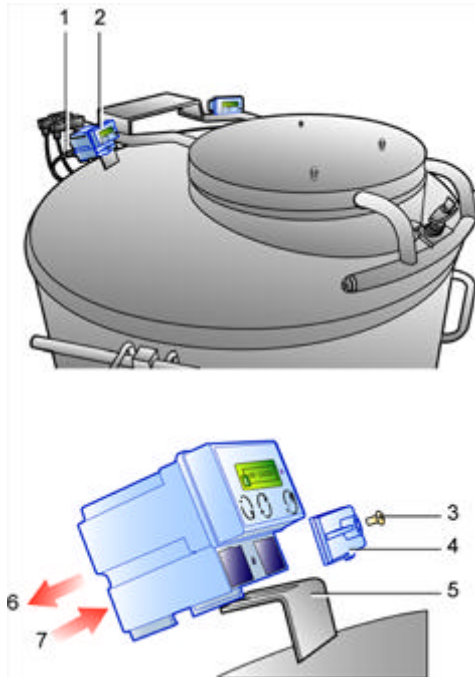

18. Electrical connections

This section specifies the wiring connections at the rear of the level or temperature indicator.

18.1 CONFIGURATIONS (REMINDER)

The four configurations are repeated below. They were dealt with in section 16 on page 85.

Type of configuration	Level control	Measurement output	See
1	By external unit	4-20 mA or RS485	§ 18.2, page 96.
2	No	RS485	§ 18.3, page 98.
3	Integral	RS485 (External Ethernet [A])	§ 18.4, page 100.
4	Integral	Integral Ethernet [B]	§ 18.5, page 102.

[A] Ethernet output via *additional Cryolink* unit. *Guaranteed traceability 21CFR, part 11.*

[B] Integral Ethernet. *No 21CFR, part 11 traceability.*

The following paragraphs give details of the different configurations.

18.2 CONFIGURATION 1 (EXTERNAL UNIT)

This configuration displays the temperature and level. An external unit controls the level.

The connections are as follows (see Figure 18-2:):

Item	Connecting cable
1.	220 V AC – 24 V AC power supply unit.
2.	Nitrogen filling pushbutton
3.	External unit
4.	Level valve.
5.	NH102885-N level indicator (without integral level control)
6.	NH102885-T temperature indicator.
7.	Connection between the level indicator and the power supply unit.
8.	Connection between the level indicator and the nitrogen filling pushbutton.
9.	Connection between the level indicator and the external unit. Please refer to the user manual for the external unit.
10.	Connection between the temperature indicator and the power supply unit.
11.	Connection between the temperature indicator and the external unit. Please refer to the user manual for the external unit.
12.	4-20 mA or RS485 output
13.	To level probe
14.	To temperature probe



The indicator does not have an *On/Off* button.

18. Electrical connections

Figure 18-1:
Connections
for the
configuration
with an
external level
control unit.

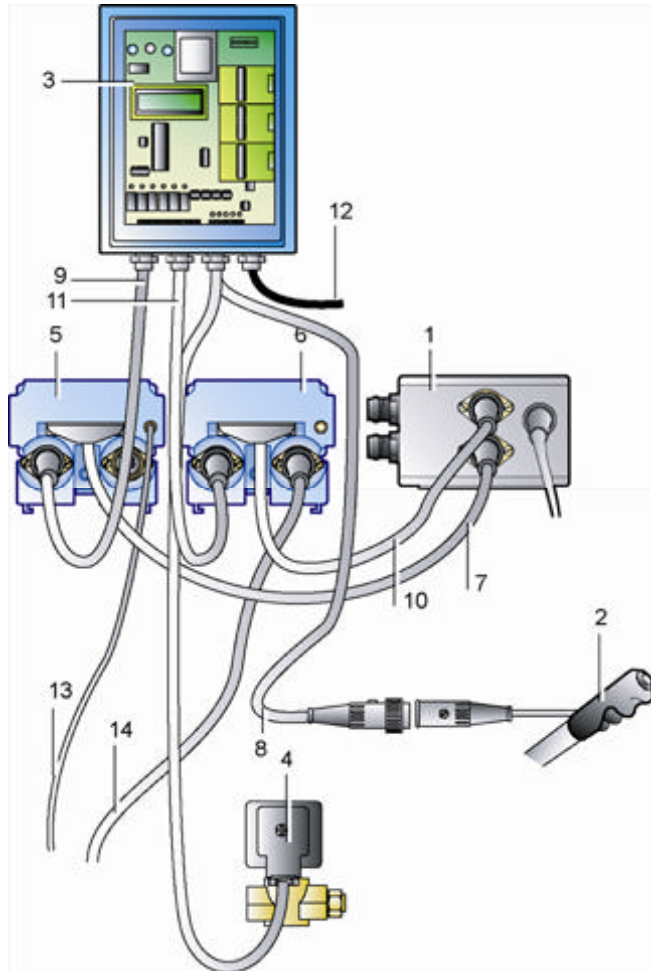

18.3 CONFIGURATION 2 (WITHOUT CONTROL)

This configuration displays the temperature and level. No level control is installed. An optional RS485-Ethernet converter allows traceability to *21CFR, part 11*.

The connections are as follows (Figure 18-3: Connections for the configuration with level control).

:

No.	Connecting cable
1.	220 V AC – 24 V AC power supply unit.
2.	<i>Cryolink</i> unit (option)
3.	Nitrogen filling pushbutton
4.	NH102885-N level indicator (without integral level control)
5.	NH102885-T temperature indicator.
6.	Connection between the level indicator and the temperature indicator.
7.	Connection between the level indicator and the power supply unit.
8.	Connection between the level indicator and the nitrogen filling pushbutton.
9.	Connection (option) between the temperature indicator and the <i>Cryolink</i> unit.
10.	Connection between the temperature indicator and the power supply unit.
11.	Ethernet output (option).
12.	RS485 output
13.	To level probe
14.	To temperature probe



The indicator does not have an *On/Off* button.

18. Electrical connections

Figure 18-2:
Connections
for the
configuration
without level
control.

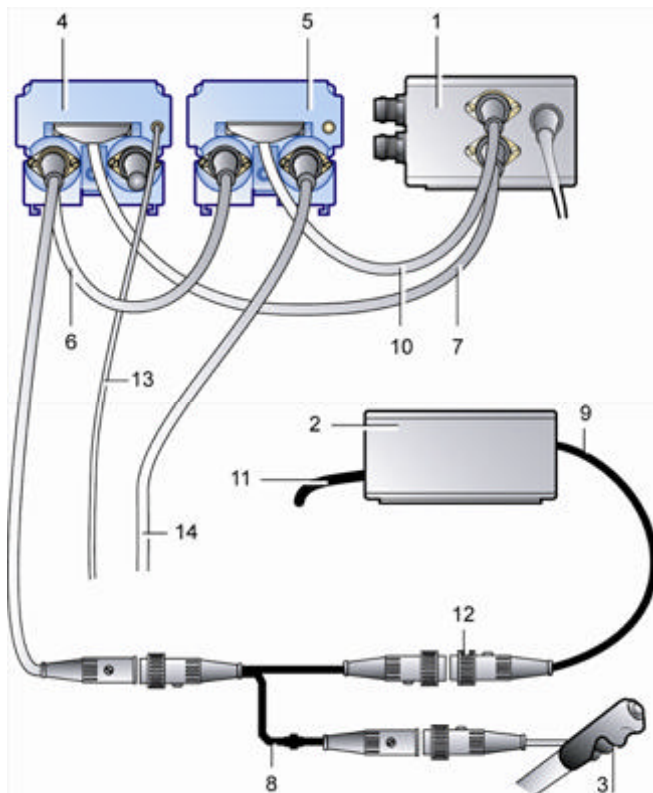

18.4 CONFIGURATION 3 (WITH LEVEL CONTROL)

This configuration displays the temperature and level. The level indicator controls the level. The optional RS485-Ethernet converter does not, however, allow traceability to *21CFR, part 11*.

The connections are as follows (Figure 18-4: Connections for a configuration with level control).

:

No.	Connecting cable
1.	<i>Cryolink</i> unit (option)
2.	220 V AC – 24 V AC power supply unit.
3.	Nitrogen filling pushbutton
4.	Level valve.
5.	NH102885-NRL or NRG level indicator (with integral level control)
6.	NH102886-T temperature indicator.
7.	Connection between the level indicator and the temperature indicator.
8.	Connection between the level indicator and the power supply unit.
9.	Connection between the level indicator, the filling pushbutton and ModBus (RS485 output.) .
10.	ModBus connection (option) between the temperature indicator and the <i>Cryolink</i> unit.
11.	Power supply to the temperature indicator.
12.	Ethernet output (option).
13.	Connection between the level indicator and the filling valve.
14.	To level probe
15.	To temperature probe
16.	Connection to manual filling pushbutton



The indicator does not have an *On/Off* button.

18. Electrical connections

Figure 18-3:
Connections
for the
configuration
with level
control.

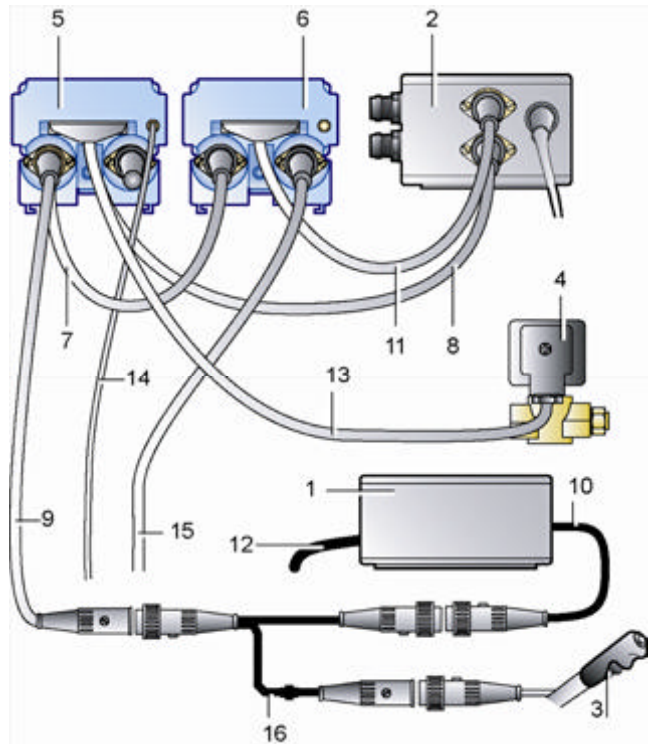

18.5 CONFIGURATION 4 (WITH LEVEL CONTROL AND ETHERNET)

This configuration displays the temperature and level. The level indicator displays the temperature and controls the level. The level is displayed on the level indicator, which also has an integral Ethernet output. However, there is no traceability to 21CFR, part 11.

The connections are as follows (see Figure 18-1: Connections for the configuration with an external level control unit.

:

No.	Connecting cable
1.	NH102887 level indicator (without integral level control)
2.	Ethernet output
3.	RS485 connection between the level indicator and the temperature indicator.
4.	NH102886-TNL or TNG temperature indicator (level control)
5.	220 V AC – 24 V AC power supply unit.
6.	Connection between the temperature indicator and the power supply unit.
7.	Connection between the level indicator and the power supply unit.
8.	Connection between the level indicator and the nitrogen filling pushbutton (9).
9.	Nitrogen filling pushbutton
10.	To level probe
11.	To temperature probe
12.	Level valve.
13.	Connection between the level indicator and the level valve.



The indicator does not have an *On/Off* button.

Figure 18-4:
Connections
for a
configuration
with level
control.

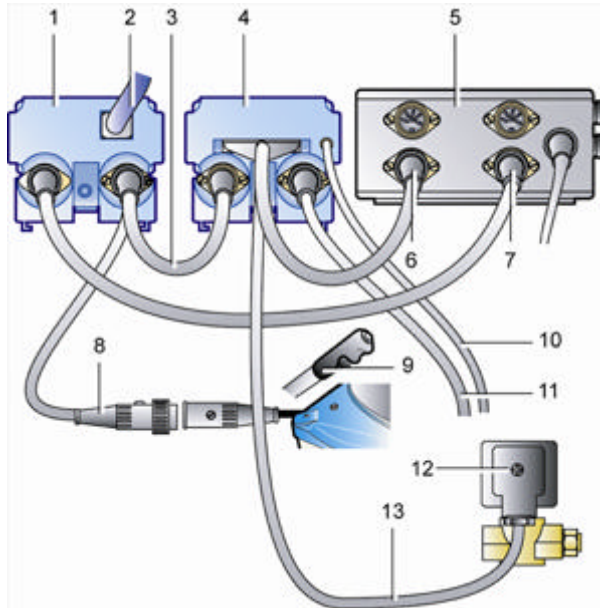

Use

19. Before using the equipment

This section summarizes all the actions that have to be taken in order to use the indicator. By following the instructions below and turning to the references shown you will be able to make full use of all the indicator functions.

19.1 TO DETERMINE THE TYPE OF INDICATOR

- Refer to paragraph 5.4 on page 27.
- The functions associated with the type of indicator are described in section 4.2 on page 12.

19.2 MECHANICAL INSTALLATIONS

Mechanical installation can be done before setting the indicator parameters or after the settings have been done in the workshop.

- **Mechanical installation before setting the parameters:** (see section 17 on page 91).
- **Mechanical installation after setting the parameters:** go straight to page 107, section 19.3, “Electrical installation after the parameters have been set”. Mechanical installation takes place after the parameters have been set.

19.3 ELECTRICAL INSTALLATION

Select one of the following two installations:

19.3.1 Electrical installation before setting the parameters

Electrical installation is done on the storage tank before the parameters are set. See section 18 on page 95 for details.

19.3.2 Temporary electrical installation

Electrical installation is done on the storage tank after the parameters have been set.

Proceed as follows:

1. **Connect the level or temperature indicator (1) to the power supply unit temporarily, using the dedicated cable (5).**

*Figure 19-1:
Connection to
the power
supply.*

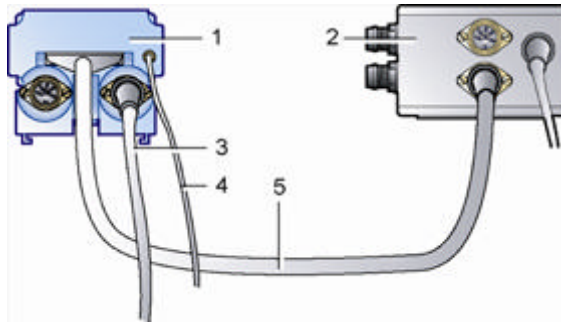

2. **Depending on the type of indicator, connect the temperature probe (3) OR the level probe (4).**
For Configuration 4 (see page 89 section 16.5), connect the temperature probe (3) AND the level probe (4) to the same indicator.
3. **Connect the power supply unit (2) to the mains.**
4. **After displaying the *Air Liquide* logo, the screen shows the level or temperature display.**
The indicator can now be set as described in section 19 on page 107.
5. **You can then disconnect the indicator in order to install it normally.**
Refer to section 18 on page 95.

19.4 SETTING THE PARAMETERS

19.4.1 “Level only” indicators (NH102885-N or NH102886-N)

Action	See §
Calling up the parameter setting menus	9.2, page 52
Entering the low level alarm	14.3, page 72
Saving the settings	11.3, page 60
The indicator is ready for use	20, page 111

19.4.2 Temperature indicators (NH102885-T or NH102886-T)

Action	See §
Calling up the parameter setting menus	9.2, page 52
Setting the units displayed (°C or °F) and the high temperature alarm	15.3, page 78
Saving the settings	11.3, page 60
The indicator is ready for use	20, page 111

19.4.3 “Controlled level” indicators (NH102886-NRG or NH102886-NRL)

Action	See §
Calling up the parameter setting menus	9.2, page 52
Entering the values shown on the screen	14.3, page 72
Saving the settings	11.3, page 60
The indicator is ready for use	20, page 111

19.4.4 “Controlled level and temperature” indicators (NH102886-TNG or NH102886-TNL)

Action	See §
Calling up the parameter setting menus	9.2, page 52
Setting the units displayed (°C or °F) and the high temperature alarm	15.3, page 78
Entering the values shown on the screen (1)	14.3, page 72
Saving the settings	11.3, page 60
The indicator is ready for use	20, page 111









(1) On the indicator the gas levels are preset and cannot be changed.





20. Use

20.1 SUMMARY OF READINGS





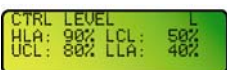



20.1.1 Description for each screen type

This section summarises all the displays that can appear on the screen and shows the sections and pages where they are explained.

Display	What it means	See details in §
	Normal display when the indicator is switched on.	6.1.1, page 31
	Level indicator, normal liquid level reading.	6.1.2, page 31
	Level indicator, the low nitrogen alarm level threshold has been reached.	6.1.3, page 32
	Temperature indicator: normal temperature reading	6.2.2, page 34
	Temperature indicator, the high temperature alarm threshold has been reached.	6.2.3, page 34
	Level indicator: measurement probe fault (Measure).	6.1.4, page 32
	Temperature indicator: temperature probe fault (Probe).	6.2.4, page 35
	Level indicator: alarm settings	10.3, page 56

	Temperature indicator: alarm settings	10.3, page 56
	Temperature and controlled level indicator: control and alarm settings	10.3, page 556
	Controlled level indicator: control and alarm settings	10.3, page 556
	Enter access code in settings screens.	9.2, page 52

20.1.2 Descriptions by type of access

Press	Display	What it means	See details in §
 and 		Level indicator: control settings	10.3, page 556
		Temperature indicator: alarm settings	10.3, page 556
		Temperature and controlled level indicator: control and alarm settings	10.3, page 556
		Controlled level indicator: control and alarm settings	10.3, page 556
 and 		Enter access code in settings screens.	9.2, page 52

20.2 USING THE LEVEL INDICATOR

This section describes the main steps taken when using the level indicator and gives the paragraph references of the explanations. It is assumed that the indicator has been installed on the tank and the electrical connections have been made.

Action	See §
Nitrogen alarm level: defining or changing the threshold	14, page 71
Nitrogen alarm level: display alarm status	5.1.2, page 16 5.1.4, page 17
Level alarm: acknowledge audible and visual alarm	6.1.4, page 32
Set the indicator parameters	19.4, page 109
Set the upper and lower levels	13, page 677
Nitrogen filling solenoid valve: manual remote control	20.6, page 1145
Passwords: entering the password	9, page 51
Nitrogen level: show	6.1, page 31
Current parameters: show alarm setting(s)	10, page 555
Filling with nitrogen: solenoid valve remote control	20.7, page 1156
Restoring the default configuration	12, page 63
Displaying the current parameters	10, page 55 6.2.5, page 35

20.3 USING THE TEMPERATURE INDICATOR

This section describes the main steps taken when using the temperature indicator and gives the paragraph references of the explanations. It is assumed that the indicator has been installed on the tank and the electrical connections have been made.

Action	See §
Temperature alarm: define or change the threshold	15, page 77
Temperature alarm: display the status	5.1.2, page 16 5.1.4, page 17
Temperature alarm: acknowledge audible and visual alarm	6.2.4, page 355
Passwords: entering the password	9, page 511
Set the indicator parameters	19.4, page 109
Current parameters: show alarm setting	10, page 555 6.2.5, page 355
Restore the default configuration	12, page 63
Current temperature: display	6.2, page 34

20.4 USING THE LEVEL AND TEMPERATURE INDICATOR

Refer to sections 20.2 and 20.3 above.

20.5 ACKNOWLEDGING THE AUDIBLE ALARM

The audible and visual alarms (buzzer and LED on front panel) are activated thirty seconds after an alarm situation occurs (level, temperature, fault etc). Press the  button to acknowledge (stop) the buzzer. The visual alarm remains active, as does the corresponding relay, if any.



The visual alarm will disappear automatically, once the cause of the alarm is no longer present. At the same time the relay will revert to no-alarm status.

20.6 MANUAL FILLING

This type of filling enables the tank to be filled manually in a few minutes. It can be done with any configuration that has a level control.

20.6.1 Using the indicator

Proceed as follows:

Step	Display	Button	Action or result
1.			The display shows the level of liquid nitrogen in the tank.
2.			Press these two buttons simultaneously to start the filling operation.
3.			Manual filling is on while the buttons are pressed in. If both buttons () are depressed simultaneously 4 times within 2 seconds, they can then be released and semi-automatic manual filling will remain on. This avoids having to keep them pressed in for long periods.
4.			Filling remains on until the upper control level UCL is reached (this abbreviation is explained in section 6.3 on page 36).

20.6.2 Using the pushbutton on the tank

Simply press the pushbutton on the tank (see page 21, Figure 5-6) and release it when the desired level is reached.



20.7 SEMI-AUTOMATIC FILLING

This type of filling enables the tank to be filled manually with nitrogen. It can only be done in the following circumstances:

- If the indicator is a type NH102886-NRL, NH102886-NRG, TNL or TNG with level control.
- If the level in the tank is between **LCL** and **UCL** (these abbreviations are explained in section 6.3 on page 36).

20.7.1 Using the indicator

Proceed as follows:

Step	Display	Button	Action or result
1.			The display shows the level of liquid nitrogen in the tank.
2.			Press these two buttons simultaneously 4 times to start the filling operation.
3.			The semi-automatic operation will fill the tank until the upper control level UCL is reached (this abbreviation is explained in section 6.3 on page 36).

20.7.2 Using the pushbutton on the tank

Simply press the pushbutton on the tank (see Figure 5-6 on page 20) **4 times**. Filling will stop automatically as soon as **UCL** is reached.

21. What to do if ...

This section deals with the faults that occur most often.

Fault	Corrective action	See §
Thresholds: the new alarm threshold has been changed but has not taken effect.	The Paramet. Storage was not used.	11, page 59
Thresholds: the level thresholds are not displayed	The type of indicator used does not have these thresholds (it is set to detect the gas level)	–
Error	Depends on the type of error	22, page 119
Problems with indicator operation	Check the power supply, wiring etc.	–

22. Error messages

Although these have already been dealt with in this manual, all the indicator messages have been collected here for the convenience of the user.

The indicator displays one of the following fault messages:



Display	Cause	Corrective action
ERR Measure	Fault in connection to temperature indicator.	Check connections.
	Level probe measurement out of range: ERR Measure appears on the display (if the level is below 0% or above 106%).	Level probe fault. Check that it is properly installed and contact your supplier.
ERR Probe	Level probe fault: probe disconnected or faulty.	Check the connections, check the probe, contact your supplier.
PARAMETERS ERROR	The values entered and confirmed during parameter setting are not correct.	Press  to close the screen and return automatically to the PARAMET. DISPLAY screen. Edit the previous settings, taking care to adhere to permitted values.
ERR internal	Internal electronic error.	Contact your supplier.

Figure 22-1:
The fault is displayed.



If there is a fault, pressing on the  button acknowledges (stops) the buzzer. The fault will remain on the display for as long as it persists and will only disappear when normal measurement is restored.

Appendices

23. Data sheet

23.1 MECHANICAL SPECIFICATIONS

Feature	Principal characteristics
Dimensions:	See Figure 23-1: Dimensions (mm)
Weight	Approx. 250 grams.
Casing	Coloured plastic.
Environment	Operating temperature: +10 °C to +45 °C. Storage temperature: 0°C to +60 °C. Relative operating humidity: 20 to 80% not condensed. Relative storage humidity: 10 to 90% not condensed.

Figure 23-1:
Dimensions
(mm)

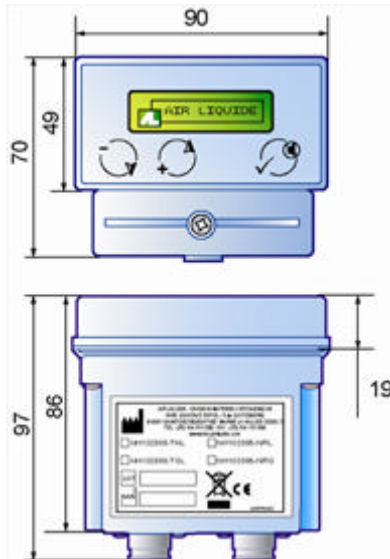

23.2 ELECTRICAL SPECIFICATIONS

23.2.1 Common specifications

Feature	Principal characteristics
Input voltage :	24 V AC.
Consumption	Approx. 300 mA at 24 V AC

23.2.2 Special characteristics

23.2.2.1 NH102885-T temperature indicator

Feature	Principal characteristics
Function:	Acquisition and display of the temperature of the liquid nitrogen in the tank for transmission of temperature data to a 4/20 mA or RS485 remote transmission unit.
Display:	Alphanumeric and graphic LCD Unambiguous display of the nitrogen temperature (can be set to °C or °F), settings and faults. Setting menus (abbreviated English) using words. Accurate to $\pm 2^{\circ}\text{C}$ over the measurement range and to $\pm 3^{\circ}\text{C}$ for temperatures transmitted to the RS485 or 4-20mA unit.
Monitor light:	Alarm LED on front panel (fault, threshold).
Audible alarm:	Coupled with the monitor light (same function). Acknowledged by pressing the  button.
Alarm (relay):	A user-definable temperature threshold between 0°C et -170°C . Programmed using the buttons. Visual (red LED) and audible (buzzer) alarms.
Alarm relay:	2 static relays with inverters for dry contacts.
Communication:	Analog signal for optional unit.
Connectors:	8-pin DIN: remote transmission of data to unit. 5-pin DIN: temperature probe 9-pin male terminal strip: supply and contacts for alarm and manual filling solenoid valve control.

23.2.2.2 NH102885-N level indicator without control

Feature	Principal characteristics
Function:	Acquisition and display of the level of the liquid nitrogen in the tank for transmission of level data to a 4/20 mA or RS485 remote transmission unit.
Display:	Alphanumeric and graphic LCD Unambiguous display of the nitrogen level, settings and faults. Clear setting menus (abbreviated English). Accurate to $\pm 2\%$ (display may fluctuate by $\pm 1\%$).
Monitor light:	Alarm LED on front panel (fault, threshold).
Audible alarm	Coupled with the monitor light (same function). Acknowledged by pressing the  button.
Alarm (relay)	A user-definable temperature threshold between 10% et 90%. Programmed using the buttons. Visual (red LED) and audible (buzzer) alarms.
Alarm relay:	1 dry contact relay RTC (common, rest, work)
Calibration:	Top and bottom of the level gauge using the display and the buttons.
Communication:	Analog signal for optional unit.
Connectors:	8-pin DIN: remote transmission of data to unit. 5-pin DIN: temperature probe 9-pin male terminal strip: supply and contacts for alarm and manual filling solenoid valve control.

23.2.2.3 Controlled level indicators NH102886-NRL and NRG

Feature	Principal characteristics
Function:	<p><i>Common specifications</i> Capture and display of the tank for transmitting level data in ModBus format (RS485 medium).</p> <p><i>Additional specifications for NH102886-NRL</i> Liquid nitrogen level control</p> <p><i>Additional specifications for NH102886-NRG</i> Gaseous nitrogen level control</p> <p><i>Additional specifications for NH102886-TNG</i> Gaseous nitrogen level control</p> <p><i>Additional specifications for NH102886-TN</i> Gaseous nitrogen level control</p>
Display:	<p>Alphanumeric and graphic LCD</p> <p>Unambiguous display of the nitrogen level, settings and faults.</p> <p>Clear setting menus (abbreviated English).</p> <p>Accurate to $\pm 2\%$ (display may fluctuate by $\pm 1\%$).</p>
Monitor light:	Alarm LED on front panel (default, threshold).
Audible alarm	Coupled with the monitor light (same function). Acknowledged by pressing the  button.
Alarm	<p><i>Specifications for NH102886-NRL only</i> Two user-definable (filling) control levels between 10% et 90%. Programmed using the buttons. Two user-definable (alarm) levels between 5% et 95%. Programmed using the buttons.</p> <p>Visual (red LED) and audible (buzzer) alarms.</p>
Alarm (relay)	1 dry contact relay RTC (common, rest, work)
Filling	Automatic, via solenoid valve controlled by level parameters. Control via the terminal strip.
Filling (relay)	1 dry contact relay RTC (common, rest, work)
Calibration:	Top and bottom of the level gauge using the display and the buttons.
Communication:	Analog signal for optional unit.
Connectors:	<p>4-pin DIN: transmission of the level data in ModBus format (RS485 medium).</p> <p>SMB: level probe</p> <p>6-pin male terminal strip – not used.</p>

24. Accessories

Item		Code
Level indicator without regulation for cabinet	NH102885-N	ACC-GNL-10
Temperature indicator for cabinet	NH102885-T	ACC-GNL-11
Independent level indicator without level control	NH102886-N	ACC-GNL-8
Independent temperature indicator	NH102886-T	ACC-GNL-9
Independent level indicator with level control	NH102886-NRL NH102886-NRG	ACC-GNL-12 ACC-GNL-5
Temperature indicator with liquid level control	NH102886-TNL	ACC-CRYOVIEW-6
Temperature indicator with gas level control	NH102886-TNG	ACC-CRYOVIEW-7
PT100 temperature sensor	4H102315	ACC-GNL-2
ESPACE 151 liquid phase capacitive level sensor	NH101490-2	ACC-CRYOBIO-2
ESPACE 331 liquid phase capacitive level sensor	NH101490-4	ACC-CRYOBIO-3
ESPACE 661 liquid phase capacitive level sensor	NH101490-6	ACC-ESP-205
RCB 500 liquid phase capacitive level sensor	NH101490-4	ACC-CRYOBIO-3
RCB 600 liquid phase capacitive level sensor	NH101490-7	ACC-RCB-102
RCB 1000 liquid phase capacitive level sensor	NH101490-8	ACC-RCB-103
RCB 1001 liquid phase capacitive level sensor	NH101490-2	ACC-CRYOBIO-2
ESPACE 151 gaseous phase capacitive level sensor	NH100222-1	ACC-ESP-200
ESPACE 331 gaseous phase capacitive level sensor	NH100222-2	ACC-ESP-201
ESPACE 661 gaseous phase capacitive level sensor	NH100222-3	ACC-ESP-202
RCB 600 gaseous phase capacitive level sensor	NH100222-5	ACC-RCB-101
RCB 1001 gaseous phase capacitive level sensor	NH100222-4	ACC-RCB-100
ARPEGE 40 liquid phase capacitive level sensor	NH98862	ACC-ARP-201
ARPEGE 55/75 liquid phase capacitive level sensor	NH98853	ACC-ARP-200
ARPEGE 70 liquid phase capacitive level sensor	NH98863	ACC-ARP-202
ARPEGE 110 liquid phase capacitive level sensor	NH98864	ACC-ARP-203
ARPEGE 140 liquid phase capacitive level sensor	NH98865	ACC-ARP-204

Continued from previous page

Item		Code
ARPEGE 170 liquid phase capacitive level sensor	NH98866	ACC-ARP-205
ARPEGE 70 gaseous phase probe and gauge	NH103647-1	ACC-ARP-402
ARPEGE 110 gaseous phase probe and gauge	NH103647-2	ACC-ARP-403
ARPEGE 140 gaseous phase probe and gauge	NH103647-3	ACC-ARP-404
ARPEGE 170 gaseous phase probe and gauge	NH103647-4	ACC-ARP-405
Degassing kit for ESPACE 151	NH102545-1	ACC-ESP-100
Degassing kit for ESPACE 331	NH102545-2	ACC-ESP-101
Degassing kit for ESPACE 661	NH102545-3	ACC-ESP-102
Degassing kit for RCB 500/600	NH1001078-1	ACC-RCB-1
Degassing kit for RCB 1000/1001	NH1001078-2	ACC-RCB-2
Anti-splash kit for <i>Espace</i> & <i>RCB</i> with 2 gauge wells on rear	NH100453	ACC-ESP-106
Anti-splash kit for <i>Espace</i> and <i>RCB</i> with 1 gauge well on rear	NH100454	
Anti-splash kit for RCB 500, 600, 1000 old generation	NH100692	
Flat RJ45 cable (blue)	NH103384	
Twisted pair RJ45 cable (white)	NH103385	
Power cable for Cryoview level indicator	4H103333	
Power cable for controlled level or temperature indicator (liquid or gas)	NH102990	
RS485 cable for indicator-to-indicator connection	4H103375	
Solenoid valve	1600026	ACC-GNL-1
220/24 V power unit – four way	NH101767	ACC-GNL-19

25. European Union Declaration of Conformity

Manufacturer
L'air liquide – DMC
Parc Gustave Eiffel
8 Avenue Gutenberg
Bussy Saint Georges
77607 Marne la vallée Cedex 3 - France



Declares that the **Indicator**

to which this declaration refers conforms to the basic description relating to electromagnetic compatibility that applies in the medical field.

The equipment bears the  mark indicating that it conforms to current European Community regulations.

To ensure that it observes good practice requirements as indicated in the directive, it has been manufactured in accordance with the following standard:

NF EN 60601-1-2: Electromagnetic compatibility of medical electrical equipment and medical electrical systems.

10 September 2005

T. Bardon

Director

26. Guarantee and limit of liability

26.1 GUARANTEE

The guarantee period takes effect on the date of issue of the equipment delivery note and has a duration of one year.

Goods are delivered at the vendor's risk where delivered by a carrier appointed by AIR LIQUIDE DMC. In other cases delivery is at the buyer's risk.

The vendor guarantees the equipment against all design faults and defects of manufacture and construction affecting the storage tanks.

The guarantee offered by the vendor is strictly limited, at the vendor's discretion, to the repair or the replacement of parts which it acknowledges as defective and to the cost of labour, not including packaging and shipping costs.

Replaced defective parts become the property of the vendor.

The repair, modification or replacement of parts during the guarantee period does not extend the duration of the guarantee.

To qualify for the guarantee, the user must submit a claim to the vendor within 15 days of its receipt of the equipment, accompanied by the delivery note.

Repairs, modifications or replacements necessary as a consequence of normal wear and tear, of damage and accidents consequent upon incorrect handling, faulty monitoring or maintenance, negligence, overloading, incorrect use, and impact, falls, or damage caused by exposure to the weather are not covered by the guarantee (see technical notes on use).

This guarantee is immediately invalidated in the event of the replacement or repair of original parts by persons not duly authorized by AIR LIQUIDE DMC.

Within the limits imposed by applicable legislation, it is expressly agreed that the guarantee awarded in this article is the only guarantee implicitly, explicitly or lawfully granted by the vendor with regard to the materials sold, and that, except where stated to the contrary in writing, the buyer renounces entitlement to any legal action which the buyer (or its employees, affiliate companies, successors or concession holders) might move against the vendor, its employees, affiliate companies, successors or concession holders, in connection with the materials sold; this provision includes without limitation actions concerning personal injury,

damage to goods not covered by the agreement, indirect or immaterial losses or damage and particularly loss of use or of profit, loss of cryogenic liquid or of products in storage etc. Within the limits imposed by applicable legislation, the buyer undertakes to compensate the vendor, its employees, affiliate companies, successors and concession holders, for all claims, complaints, demands, court orders, convictions or liabilities of any nature, as well as all costs and expenses incurred by or imposed on the vendor in connection with the materials sold.

Replacement parts must be used in the conditions of service originally defined by the vendor. In particular, safety devices sold as replacement parts must be installed as replacements for the original safety devices in conditions of service (pressure, temperature, gas, valve diameter etc.) identical to the original.

Application of this guarantee takes place in accordance with the vendor's general terms and conditions of sale.

26.2 LIMIT OF LIABILITY

Neither *L'AIR LIQUIDE-DMC* nor any company associated thereto can be held liable under any circumstances for any damage, including and without limitation to damages incurred as a result of loss of manufacture, interruption of manufacture, loss of information, failure of the indicator or of its accessories, bodily injury, loss of time, financial or material loss or any indirect or ancillary consequences of loss arising from the use, or impossibility of use of, the product, even in cases where *L'AIR LIQUIDE-DMC* has been notified of such damage.

27. Index

- button, 17
- ✓ button, 17
- (✓) button, 16
- (-) button, 16
- (+) button (+), 16
- + button, 17
- °C, 37, 80
- °F, 37, 80
- 24 V AC, 23
- 4-20 mA, 13
- 4-pin DIN, 20
- 5-pin DIN, 26
- 8-pin DIN, 21
- Accessories, 131
- Acknowledge alarm, 124
- Acknowledge audible alarm, 17, 36, 119
- Acknowledge buzzer, 16, 34
- Acrobat Reader*, 2
- Alarm
 - Audible, 19
 - Audible/visual, 42, 45
 - Fault, 33
 - Indicator light, 18
 - Nitrogen level, 33
 - Temperature, 35
- Alarm indicator, 18
- Alarm indicator light, 18
- Alarm LED, 18
- Alarm threshold
 - Setting the HTA, 81, 125
- Arpège, 96
- Articles supplied, 7
- Audible alarm, 19
 - Acknowledge, 34, 36, 119, 124
- Baud rate, 82
- Bottom panel, 27
- Buzzer, 16, 19, 42, 45, 119, 128, 129, 130
 - Acknowledge, 16, 18
 - Stopping, 19
- Buzzer/LED, 42
- Cabinet, 21
 - Configuration, 88, 99
- Calibration, 69
- CALIBRATION, 38
- Casing, 127
- CD Rom, 2, 7
- CE, 5, 27, 133
- CE mark, 5
- CEI, 4
- Celsius, 37
- CEM, 4
- Centigrade/Fahrenheit
 - Conversion, 83
- Code
 - Entering, 54
- Communication, 128, 129
- Configuration
 - Cabinet, 88
 - Level and temperature, 91
- Confirm, 62
- Connection
 - Fault, 124
- Connectors, 12, 19, 128, 129
- Consumption, 128
- Control
 - Controlled level, 44
 - Level only, 42

- Temperature, 41
- Controlled level, 44, 58, 59
- CONTROLLED LEVEL, 38
- Conversion
 - Centigrade/Fahrenheit, 83
- Copyright, ii
- Corrective action, 124
- Cryoview*, 13
- Current parameter settings
 - Display, 34
 - Display, 36
- DATA TRANSF. RATE, 38
- Data/Clock, 22
- Declaration of conformity, 133
- Decrementation, 17
- Default configuration
 - Restoring, 28
- Description, 16
- Destruction, 6
- Dimensions, 127
- Display, 16, 32, 128, 129
 - Information, 35
 - Parameter settings, 37
 - Summary, 114
 - Symbols, 37
 - Texts, 38
- Displayed units
 - Temperature, 80
- Earth, 23
- Electric wiring, 98
- Electrical power cable, 7
- Electrical specifications, 128
- e-mail, ii
- Empty*, 70
- EMPTY, 38
- Environment, 127
- Equipment
 - Destruction, 6
- ERR internal, 124
- Err measure, 36
- Err Measure, 36, 124
- Err Measure, 33
- Err probe, 33, 36
- ERR Probe, 124
- Error, 18
 - Messages, 124
- Error messages, 124
- Espace without fairing, 95
- Factory Paramet., 65
- FACTORY PARAMET., 38
- Factory parameters*, 28, 66
- Fahrenheit, 37
- FAHRENHEIT DISP., 38
- Fahrenheit/Centigrade
 - Conversion, 83
- Faired *Espace*, 94
- Fault, 5, 33, 36
- Fault (cause), 124
- Fault alarm, 16
- filling
 - Semi-automatic, 121
- Filling
 - Manual, 120
 - Solenoid valve, 21
- Filling valve, 21
- Frame, 23
- Front panel, 16
- Front panel, 11
- Full*, 70
- FULL, 38
- Function, 13
- GASEOUS, 38
- General safety precautions, 4
- Graphics, 41
- Guarantee, 135
- HIGH LEVEL ALARM, 38
- High temperature alarm, 37
- HLA, 18, 26, 33, 37, 40, 58, 68
- HTA, 18, 35, 37, 40, 58, 59, 68, 81
- http, ii
- Humidity, 127
- Incrementation, 17
- Indicator*, 7
 - Connectors, 12

- Displays, 32
 - General, 11
 - Rear panel, 12
- Indicator light, 16
- Key, 53, 54
- KEY, 38
- Label, 28
- LCD, 16, 32, 128, 129
- LCL, 25, 26, 37, 40, 58, 68, 75
- Level
 - Alarm, 33
 - Default parameters, 68
 - Use, 117, 119
- LEVEL, 38
- Level display
 - Alarm, 33
 - Normal, 32
 - Parameter settings, 34
- Level indicator
 - Fault, 33
 - Rear panel, 19
 - Starting up, 32
- Level only, 42, 68
- Level Paramet, 73
- LEVEL PARAMETERS, 38
- Level probe, 99, 101, 103, 105
 - Fault, 33, 124
 - Out of range, 36
- Level sensor
 - Socket, 27
- Level with control, 68
- Level without control, 58
- Limit of liability, 136
- LLA, 18, 26, 33, 37, 40, 58, 68, 75
- Low level alarm
 - Setting, 75
- LOW LEVEL ALARM, 38
- Lower control level
 - Setting, 75
- LOWER CTRL LEVEL, 38
- Manual, 7
 - Purpose, 1
- Quick consultation, 2
 - Reader, 1
 - Use, 1
- Manual control, 21
- Manual control pushbutton, 21
- Mechanical installation, 94
- Mechanical specifications, 127
- Menu
 - Calibration, 69
 - Factory Paramet., 65
 - Key, 53
 - Level Paramet, 73
 - Paramet. Display, 57
 - Paramet. Storage, 61
 - Temp. Parameters, 79
- Menus
 - Comparison, 49
- ModBus, 20, 22, 68, 103
 - Address, 77
 - Signal frame, 28
- ModBus address
 - Setting, 77
- MODBUS ADDRESS, 38
- NH102885-N, 7, 13, 26, 49
- NH102885-T, 7, 13, 26, 49
- NH102886-N, 7, 13, 49
- NH102886-NRG, 7, 13, 26, 49
- NH102886-NRL, 7, 13, 26, 49
- NH102886-T, 7, 13, 49
- NH102886-TNG, 7, 13, 26, 27, 49
- NH102886-TNL, 7, 13, 26, 27, 49
- Nitrogen level, 33
- NO, 38
- OK, 17
- Operating temperature, 127
- Paramet. Display, 57
- PARAMET. DISPLAY, 38
- Paramet. Storage, 61
- PARAMET. STORAGE, 38
- PARAMETER ERROR, 38
- Parameter settings
 - Display, 34, 37

- RS485 transmission rate, 82
- Parameters
 - Confirm, 62
 - Default, 28, 66
 - Factory, 66
- PARAMETERS ERROR, 124
- Power supply, 23
- Product code, 28
- Pushbutton
 - Tank, 120, 121
- Pushbutton, 99, 101, 103, 105
- Rate, 68
- RCB, 97
- Readings on screen
 - Summary, 114
- Rear panel, 12
- Reference, 28
- Relay
 - Alarm, 42, 45
 - Level, 42
- RS485, 13, 20, 22
 - Rate, 77
 - Signal frame, 28
- RS485 connector, 20
- RS485 output, 20
- Safety, 3
 - Liquid nitrogen, 5
 - Operators, 4
- Settings
 - All indicators, 112
- SIMPLE LEVEL, 38
- SMB, 27
- Socket
 - Level sensor, 27
 - Temperature sensor, 26
- Stopping the alarm, 19
- Storage tank
 - Arpège, 96
 - Espace without fairing, 95
 - Faired *Espace*, 94
 - RCB, 97
- Storage temperature, 127
- Structure of an installation, 87
- Supply terminals, 23
- Supply voltage, 128
- Supply voltage, 128
- Symbols, 37
- Tank
 - Pushbutton, 120, 121
- Temp. Parameters, 79
- TEMP. PARAMETERS, 38
- Temperature, 35, 37, 58, 68
 - Alarm, 36
 - Default parameters, 68
 - Displayed units, 80
 - Threshold reached, 37
 - Units, 68
 - Use, 119
- TEMPERATURE, 38
- Temperature alarm
 - Fault, 36
- TEMPERATURE ALARM, 38
- Temperature and controlled level, 59, 68
- Temperature display
 - Alarm, 35
 - Fault, 36
 - Normal use, 35
 - Starting up, 35
- Temperature probe, 99, 101, 103, 105
 - Fault, 36
 - Out of range, 36
- Temperature sensor
 - Socket, 26
- Terminal 1, 23
- Terminal strip, 22
- Terminals 4, 5 and 6, 24
- Terminals 7, 8 and 9, 25
- Texts, 38
- The CE mark, 5
- Top panel, 27
- Trade names quoted, 2
- Transmission rate
 - Setting, 77

UCL, 18, 25, 26, 37, 40, 58, 68, 76

Upper control level
Setting, 76

UPPER CTRL LEVEL, 38

Use, 114

Level, 117, 119

Temperature, 119

Validation, 17

web page, ii

Weight, 127

Wiring

Cabinet, 99

Level and temperature, 105

www, ii



L'air liquide – DMC
Parc Gustave Eiffel
8 Avenue Gutenberg
Bussy Saint Georges
F – 77607 Marne la vallée Cedex 3
Tel: +33 (0) 1.64.76.15.00
Fax: +33 (0) 1.64.76.16.99
Web: www.airliquide.com